

DATE
APRIL 26, 2004
CATALOG NO.
HB0032

OUTLINE DIMENSIONS
3-PHASE INDUCTION MOTOR

MOTOR TYPE:
AEHH8B
FRAME NO. 182T

Pole	HP	KW	Hz	VOLT	Syn.Speed RPM
2	3	2.2	60	460	3600

Ins	Rating	Dimension in	Approx Weight	Bearings
F	CONT.	inches	84 lbs.	DE: 6306ZC35C NDE: 6306ZC35C

Totally Enclosed Fan-Cooled Type.Squirrel-Cage Rotor.

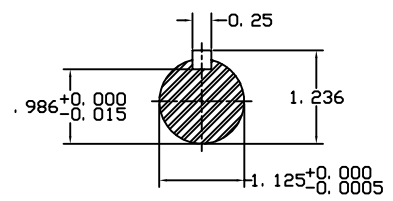
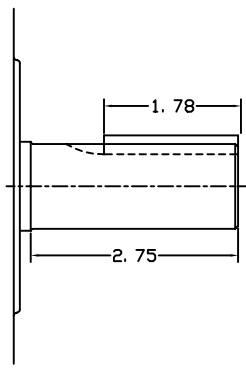
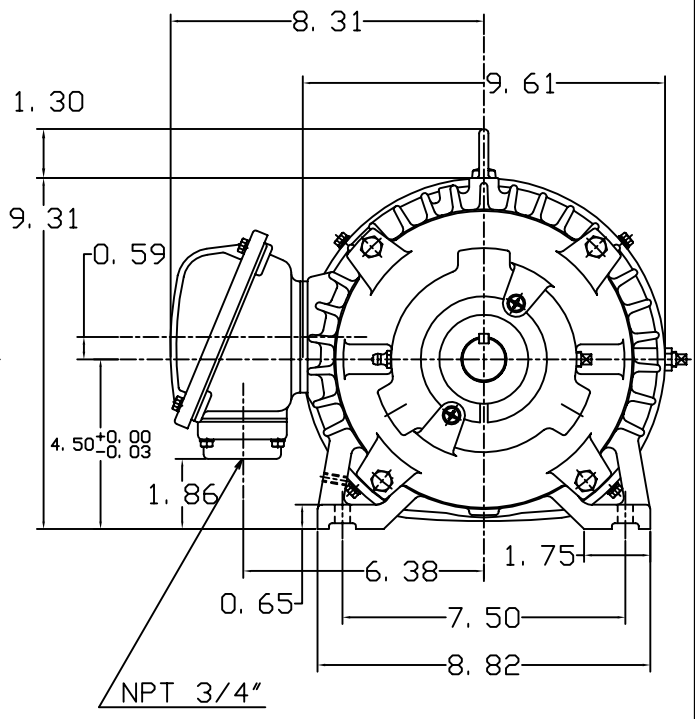
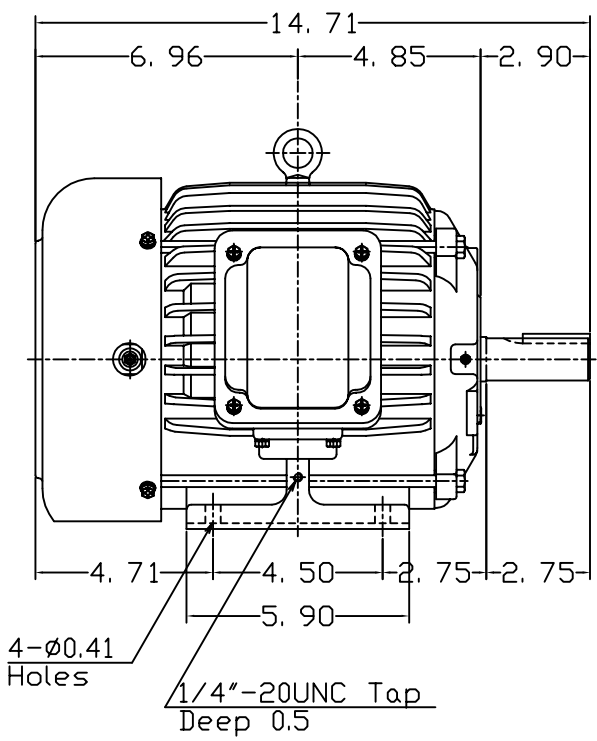

+

DWN.	胡峰誠	11-12-98
CHKD.	羅清水	11-23-98
APPD.	黃友伯	11-23-98



DWG NO.
31049HB891001