

CATALOG #	TYPE	FRAME	OUTPUT		POLE	SYN. SPEED R.P.M.	VOLTAGE V.	Hz.	TIME RATING	INSULATION CLASS	SERVICE FACTOR	WEIGHT LBS
			HP	kW								
WPV0/72C	AEGP	A56C	.75	.56	2	3600	230/460	60	CONT.	F	1.15	33 LBS.

TOTALLY ENCLOSED FAN-COOLED TYPE. SQUIRREL CAGE MOTOR

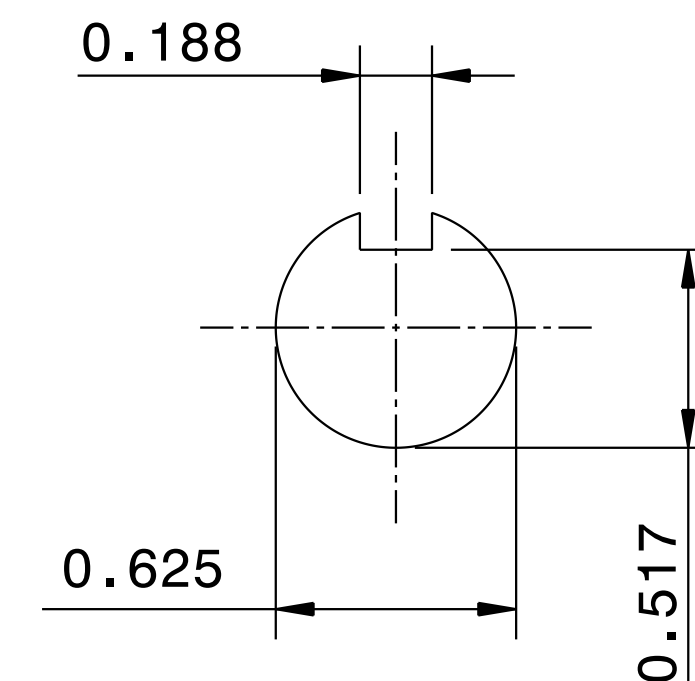
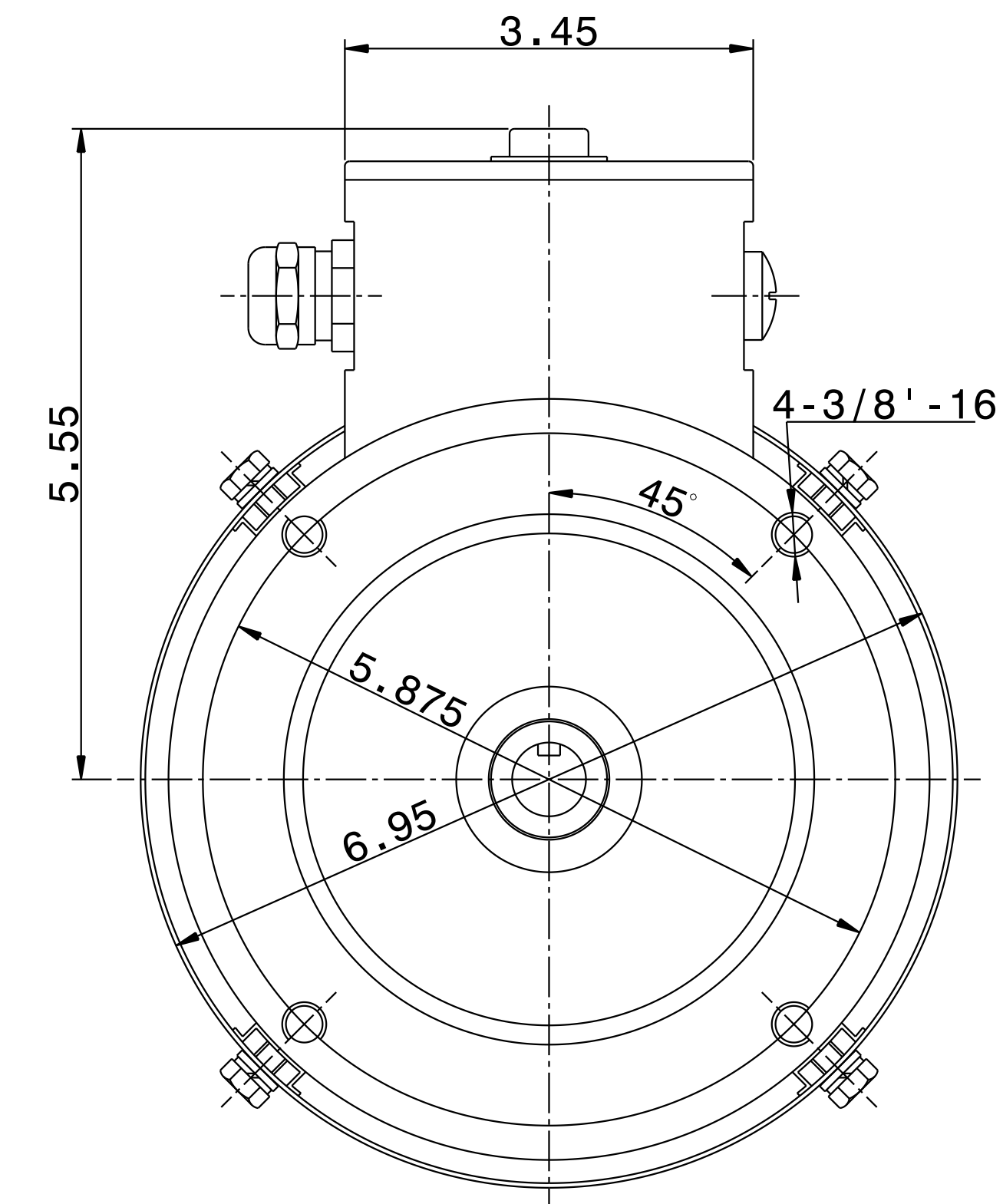
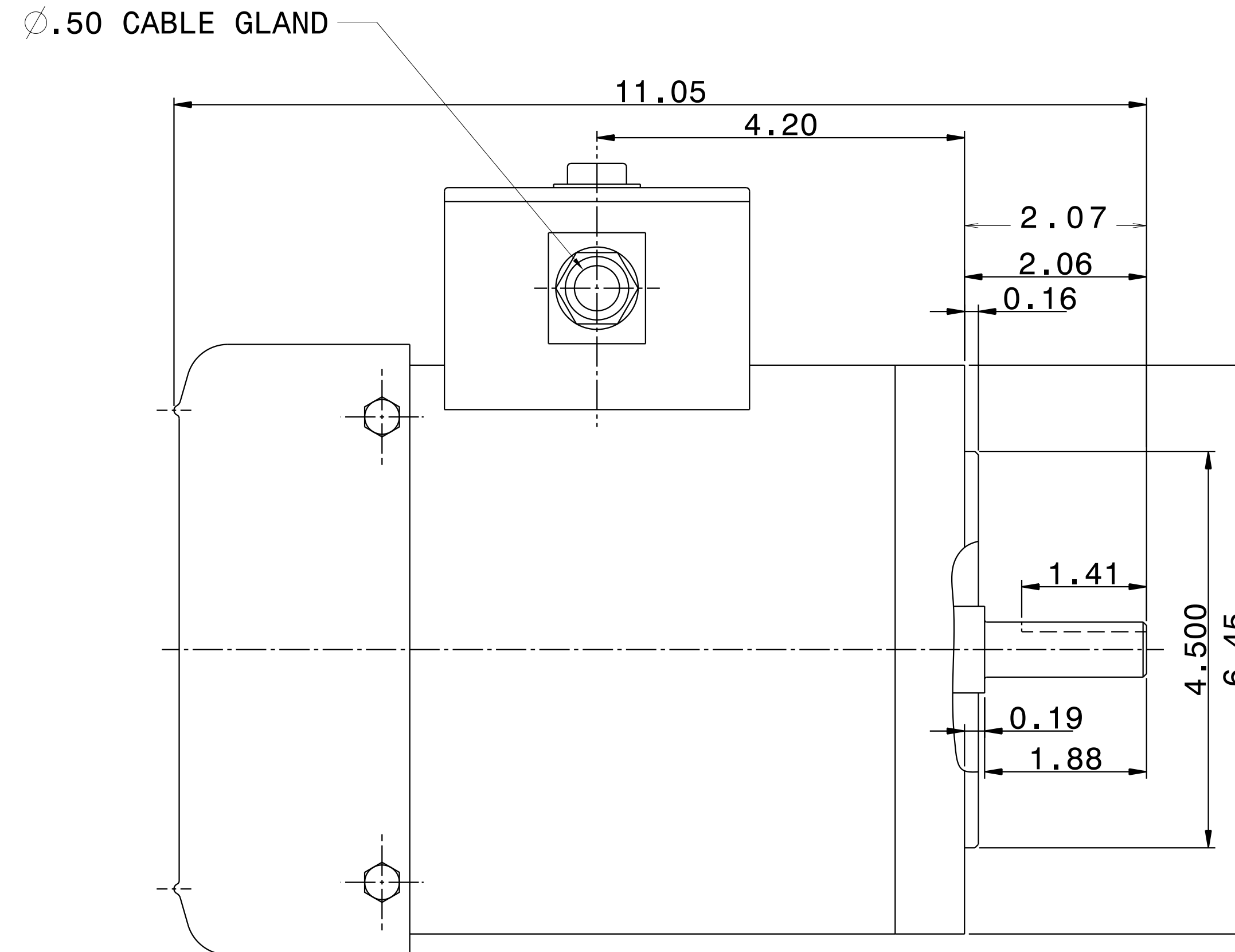

- NOTES: 1. DIMENSIONS IN INCH.
 2. ENCLOSURE: IP56.
 3. FOR DIRECT FLEXIBLE COUPLING.
 4. STAINLESS STEEL CONSTRUCTION.

REF: 31049J806230	REV. DATA		REV NO	
	TECO Westinghouse		01	
	3-PHASE INDUCTION MOTOR OUTLINE DIMENSIONS		DWG NO. WPV0/72C	
	DWN T. FELPS	020713	APPD S. GROHOSKY	020713
TECO-WESTINGHOUSE MOTOR COMPANY		ROUND ROCK, TEXAS USA		