

THIS IS AN UPDATED REVISION, THE PREVIOUS ONE MUST BE DISREGARDED.

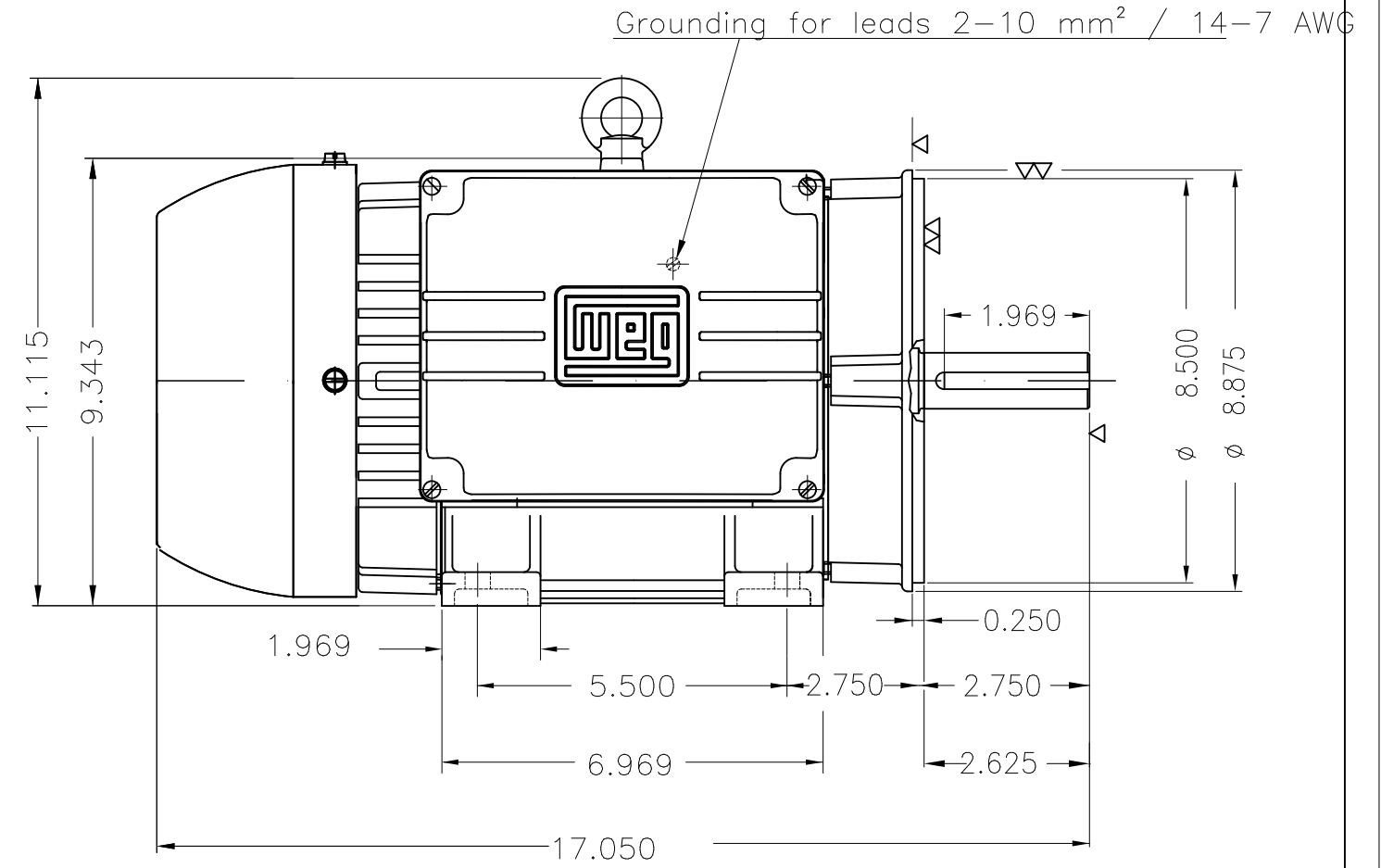
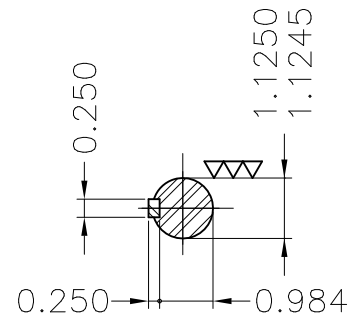
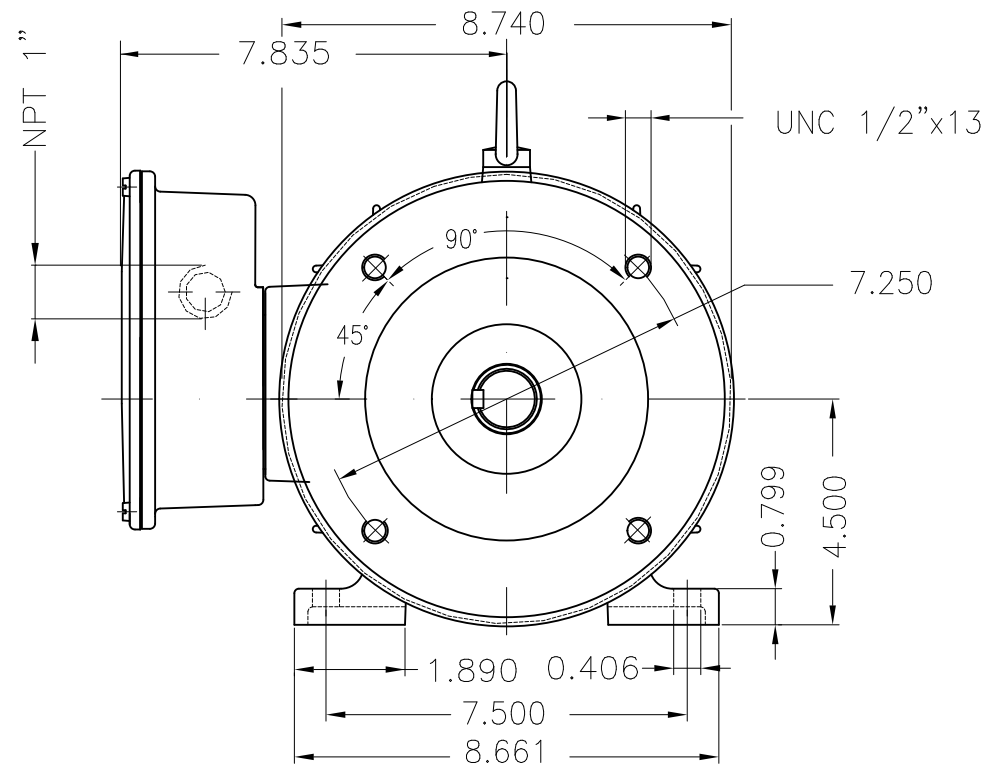

Bearing cap									
Mounting B34R(D)									
ECM	LOC	SUMMARY OF MODIFICATIONS			EXECUTED	CHECKED	RELEASED	DATE	VER
EXECUTED	USERADMIN	SINGLE PHASE MOTOR							
CHECKED		FRAME 184TC IP55 TEFC							
RELEASED		WEG code: 10016384							
REL DT	24.07.2017	WMO	Jaragua do Sul	Product Engineering	SHEET	1 / 1			

5 HP 02 Poles 60Hz

A

