

DATE
Sept. 25, 2006
Cat. #: EP0152C

OUTLINE DIMENSIONS
3-PHASE INDUCTION MOTOR

MOTOR TYPE:
AEHH8N-CF
FRAME NO. 254TC

Pole	HP	kW	Hz	VOLT	Syn. Speed r/min(rpm)
2	15	11.2	60	230/460	3600

Ins	Rating	Dimension in	Approx Weight	Bearings
F	CONT.	inches	310 lbs	DE: 6309ZZ NDE: 6307ZZ

Totally Enclosed Fan Cooled Type. Squirrel-cage Rotor.

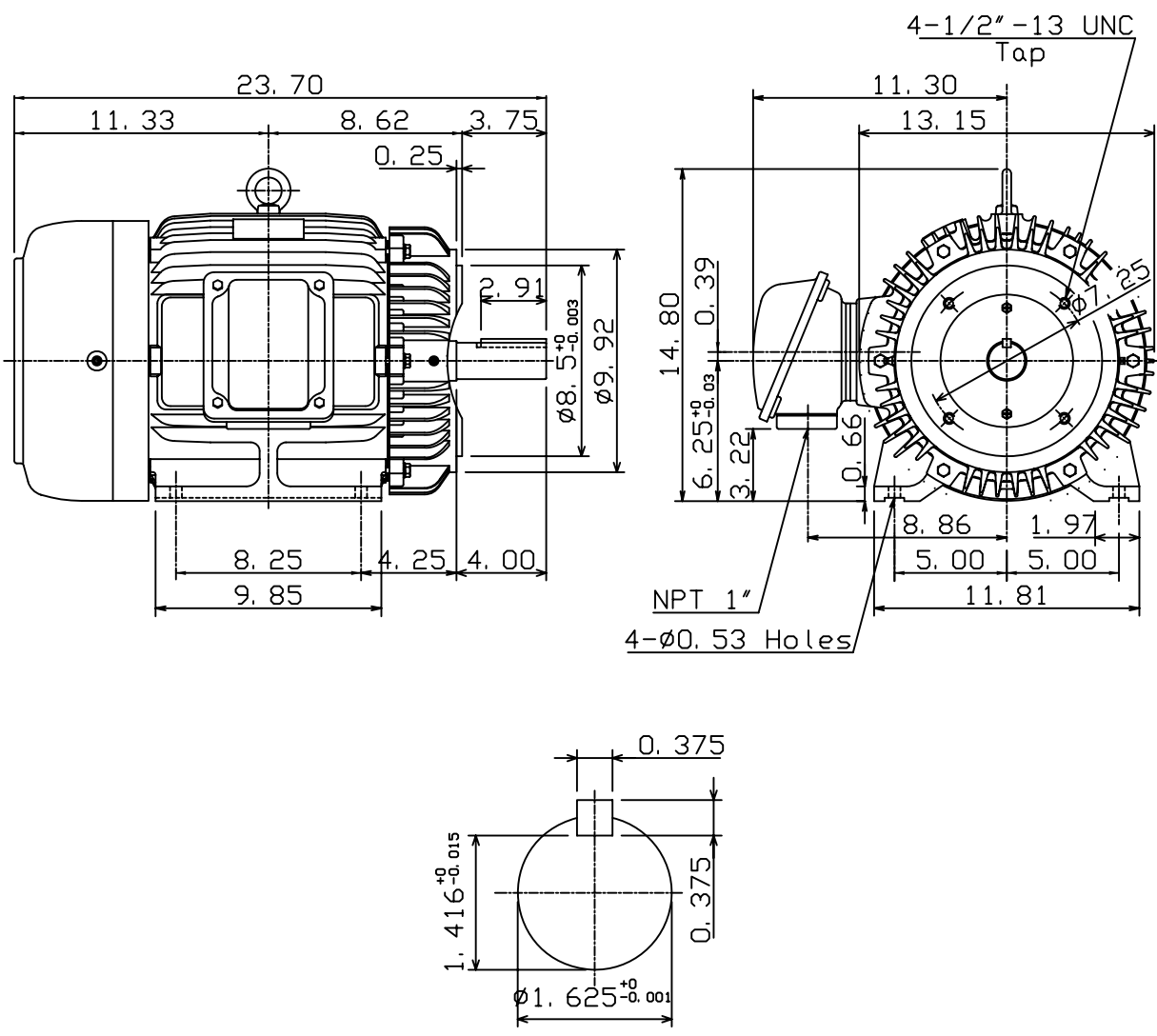

① 01. 10. 05 K. L. KUO

DWN.	K. L. KUO	11-03-04
CHKD.	C. H. KAO	11-04-04
APPD.	M. C. TSAI	11-04-04



DWG NO.
31049J811191