

Dimensões em polegada
Dimensions in inches

THIS IS AN UPDATED REVISION, THE
PREVIOUS ONE MUST BE DISREGARDED.

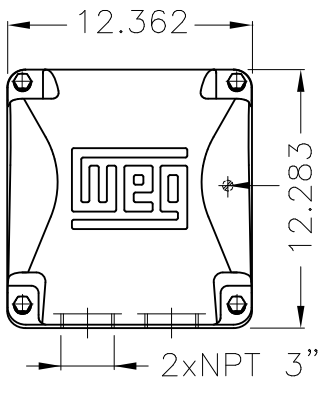

Grounding for leads 35-70 mm² / 1-2/0 AWG

Main terminal box

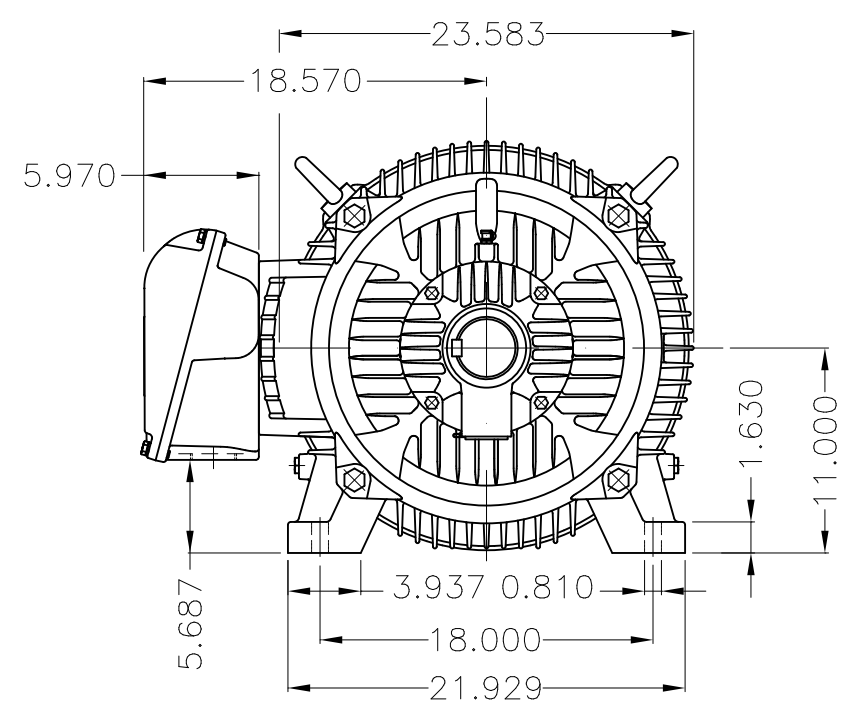

Grounding for leads 25-185 mm² / 3AWG-350MCM

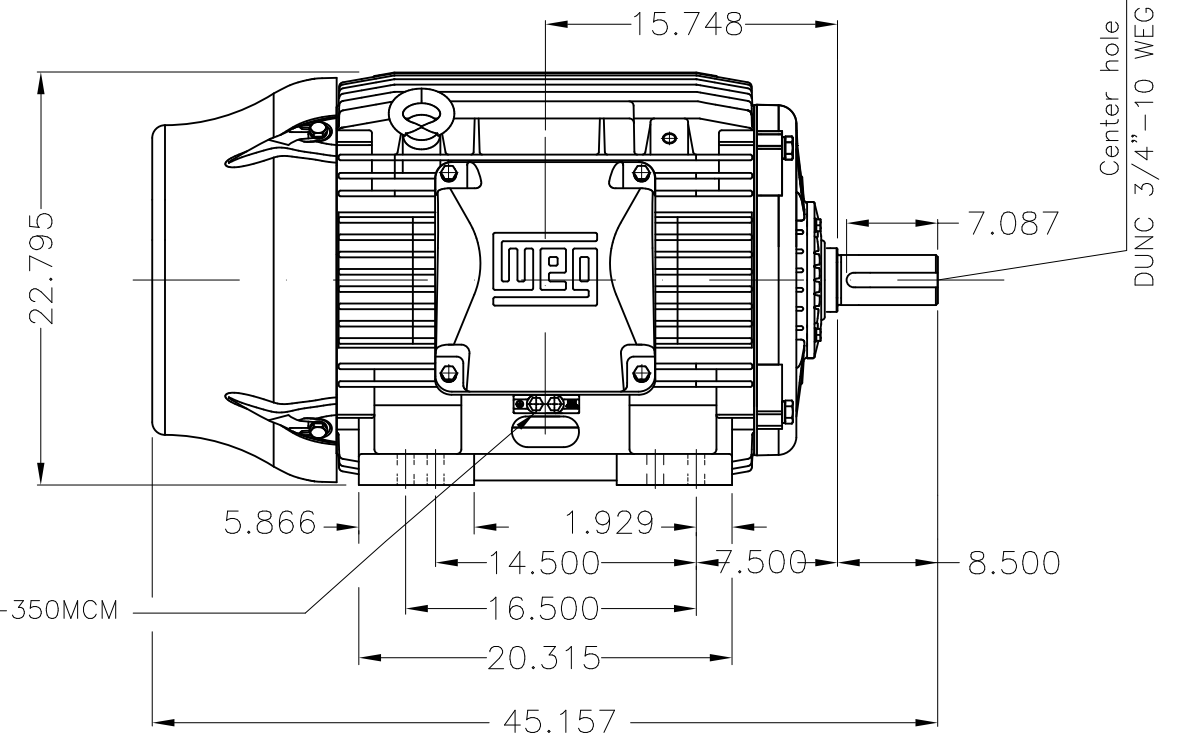

Center hole
DUNC 3/4"-10 WEG TBG12



DE Shaft End

Color RAL 5009
Painting plan 203A
Mounting B3R(D)

ECM	LOC	SUMMARY OF MODIFICATIONS			EXECUTED	CHECKED	RELEASED	DATE	VER
EXECUTED	USERADMIN		THREE PHASE W22 MOTOR - NEMA PREMIUM EFF						
CHECKED			FRAME 444/5T IP55 TEFC						
RELEASED			WEG code: 11355769						
REL DT	24.07.2017	WMO	Jaragua do Sul	Product Engineering	SHEET	1 / 1			

125 HP 04 Poles 60Hz

A



ZME A3