

INDEX	SAS013486
REV. LEVEL	01
SHEET	1 OF 1

TOSHIBA/HOUSTON

OPEN DRIP-PROOF  
HORIZONTAL FOOT-MOUNTED

Fr. 254T

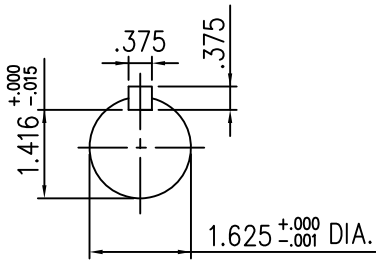
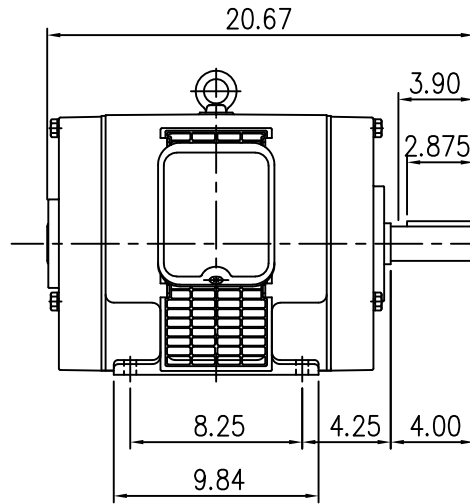
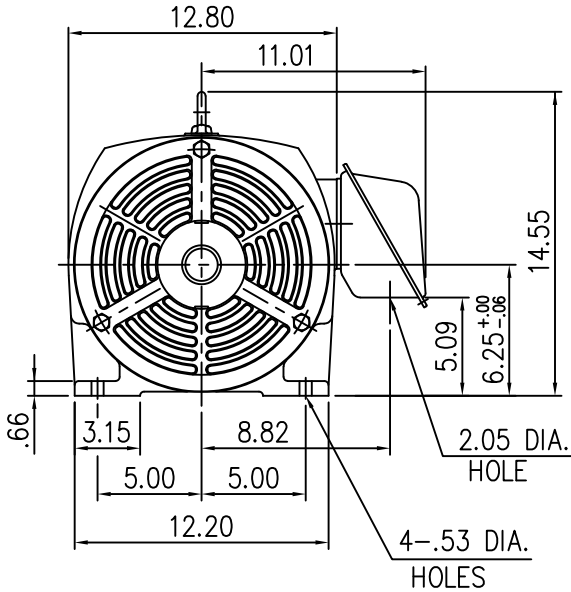

- (1) DIMENSIONS ARE IN INCHES
- (2) DRIVE END BEARING 6310C3  
OPPOSITE DRIVE END BEARING 6208C3
- (3) LEAD WIRE: 8 FEET LENGTH

ALL DATA SUBJECT TO CHANGE WITHOUT NOTICE.  
FOR CONSTRUCTION USE ONLY CERTIFIED DATA.

CERTIFIED DATA

CUSTOMER: \_\_\_\_\_ P.O. NO.: \_\_\_\_\_ TAG NO.: \_\_\_\_\_  
MOTOR MODEL NO.: \_\_\_\_\_ TOSHIBA FILE NO.: \_\_\_\_\_  
HP: \_\_\_\_\_ RPM (SYN.): \_\_\_\_\_ VOLTAGE: \_\_\_\_\_ Hz: \_\_\_\_\_  
FRAME SIZE: \_\_\_\_\_ LOG NO.: \_\_\_\_\_ LOG REV. LEVEL: \_\_\_\_\_  
REMARKS: \_\_\_\_\_  
PER: \_\_\_\_\_ ISSUE DATE: \_\_\_\_\_ SUPERSEDES: \_\_\_\_\_