

INDEX	SAS013491
REV. LEVEL	01
SHEET	1 OF 1

TOSHIBA/HOUSTON

OPEN DRIP-PROOF
HORIZONTAL FOOT-MOUNTED

Fr. 364T

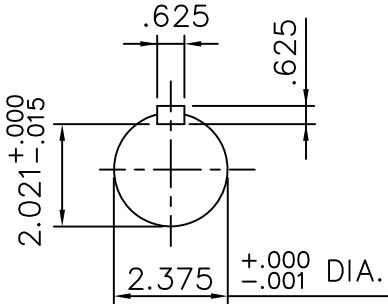
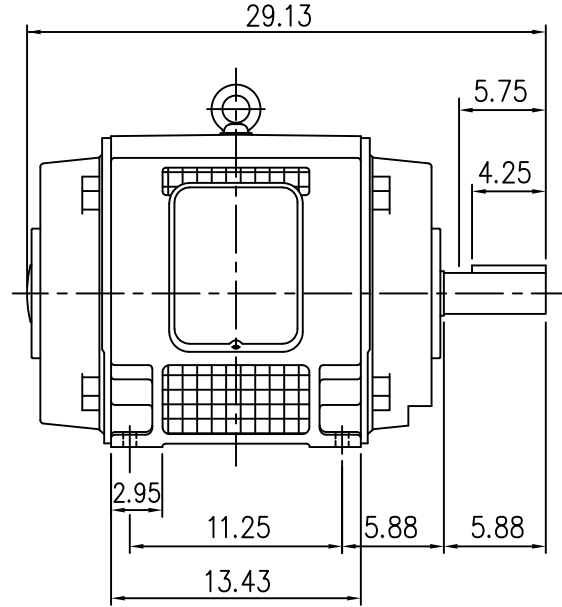
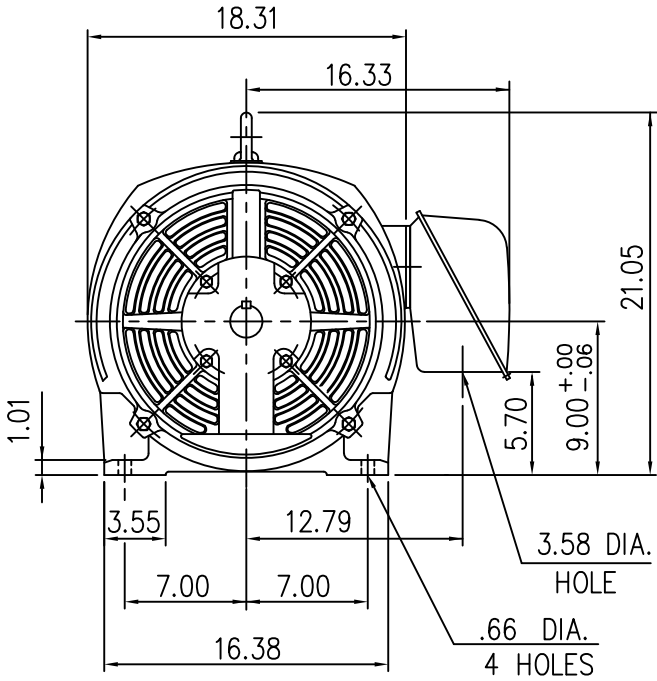

- (1) DIMENSIONS ARE IN INCHES
- (2) DRIVE END BEARING 6314C3
OPPOSITE DRIVE END BEARING 6313C3
- (3) LEAD WIRE: 8 FEET LENGTH

ALL DATA SUBJECT TO CHANGE WITHOUT NOTICE.
FOR CONSTRUCTION USE ONLY CERTIFIED DATA.

CERTIFIED DATA

CUSTOMER: _____ P.O. NO.: _____ TAG NO.: _____
MOTOR MODEL NO.: _____ TOSHIBA FILE NO.: _____
HP: _____ RPM (SYN.): _____ VOLTAGE: _____ Hz: _____
FRAME SIZE: _____ LOG NO.: _____ LOG REV. LEVEL: _____
REMARKS: _____
PER: _____ ISSUE DATE: _____ SUPERSEDES: _____