

ø3/4"-10 UNC 4 PLACES FOR JACKING BOLTS

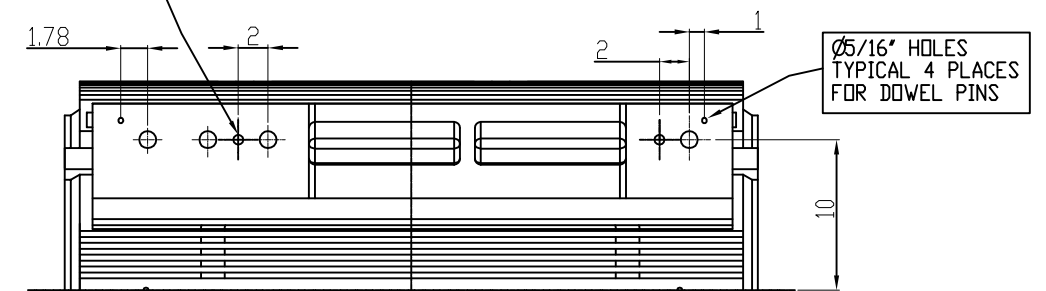

UNITS: INCHES

TECHNICAL INFORMATION

1. BEARING LUBRICATION DE: MOBIL POLYREX EM
ODE: MOBIL POLYREX EM
2. BEARING TYPE DE: 6320C3
ODE: 6320C3 INSULATED
3. WINDING TEMP. DETECTORS
NUMBER AND TYPE: 6xRTD(Pt0°C-100ohm)
LOCATION: IN STATOR SLOT
4. BEARING TEMP. DETECTORS
NUMBER AND TYPE: _____
5. SPACE HEATER 1 PHASE
VOLTS: 120 WATTS: 240
6. ROTATION: CCW VIEWED FROM NON DRIVE END
THIS MOTOR IS BI DIRECTIONAL
7. MOTOR PAINT COLOR: GRAY
8. APPROX. WEIGHT: 5000 Lbs
9. ACCESSORIES:

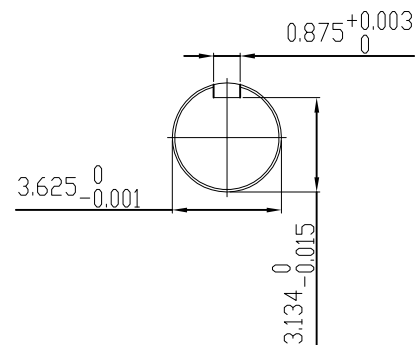

DRAWING LIST

MAIN TERMINAL BOX 130-7622-55					
AUX TERMINAL BOX FOR					
SPACE HEATER	130-7520-50	2	GRS FROM SRI, ADD DOWELS JACKING TO INLINE	RWS	1/6/14
R.T.D.	130-7522-51	1	CHG FAB. FC FOR C.I. FC	JMP	9/24/08
THERMISTOR	N/A				
		0	FIRST ISSUE	BCS	4/24/07
PRODUCTION #	N/A	NO.	REVISION	BY	DATE

MOTOR OUTLINE FOR THREE PHASE INDUCTION MOTOR

CUSTOMER NAME				P.O. NO.	MOTOR TAG NO.	
OUTPUT HP	POLE	VOLTAGE V	FREQUENCY Hz	FULL LOAD SPEED (min ⁻¹)	TOSHIBA MODEL NO.	
TYPE	FORM	INS. CLASS F	RATING CONT.	FRAME 5011US	S.F.	ENCLOSURE TEFC
TOSHIBA INTERNATIONAL CORPORATION HOUSTON, TEXAS U.S.A.						
3rd ANGLE PROJ.	PREPARED BY: B SIDLE	DATE: 4/24/07	CHECKED BY: S Johnson	DATE: 4/26/07	DRAWING NO.: MDSL0071-15	REV. 2