

4

3

Uncontrolled Copy

2

1

B

B

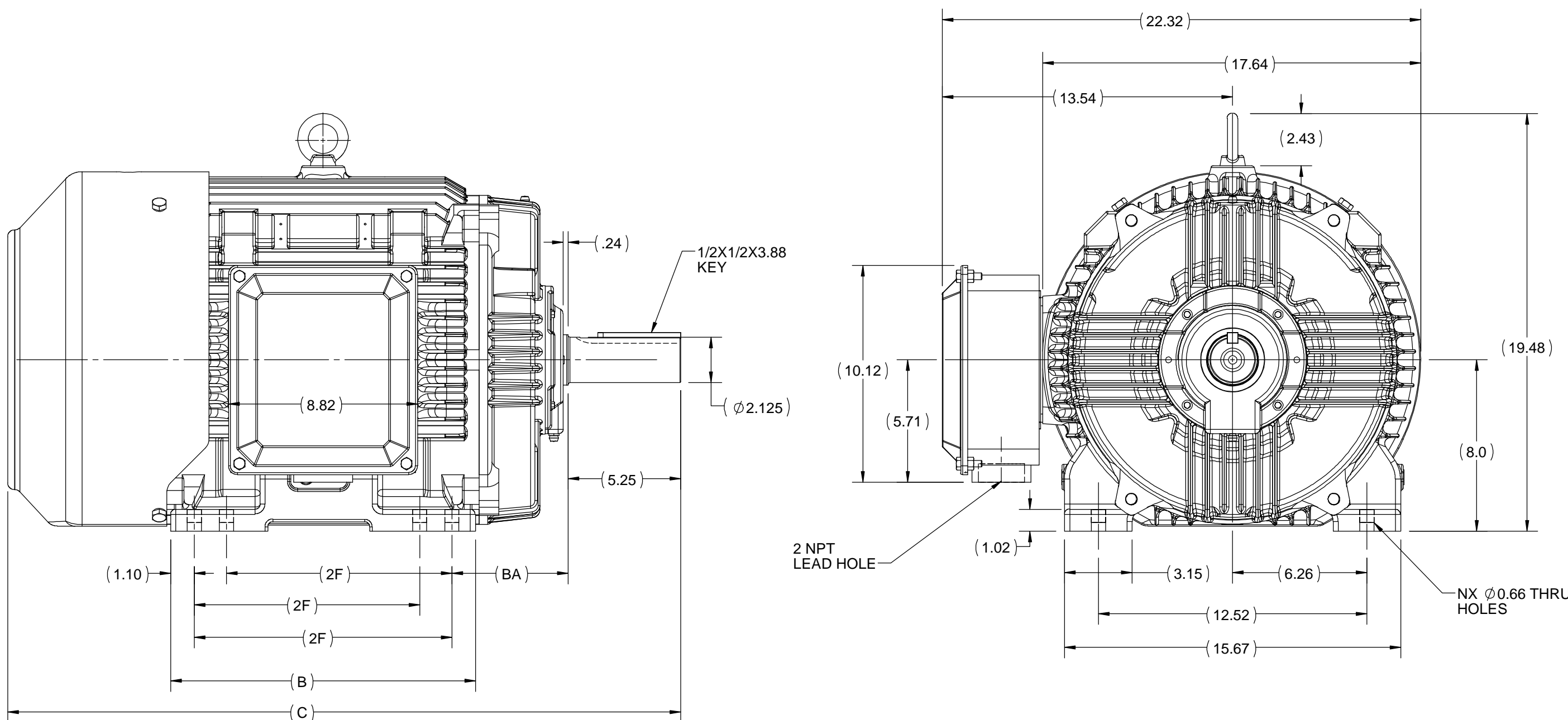



A

A

326T	14.21	31.19	12.0	8	5.25
324T	12.71	29.69	10.5	4	5.25
FRAME	B	C	2F	N	BA

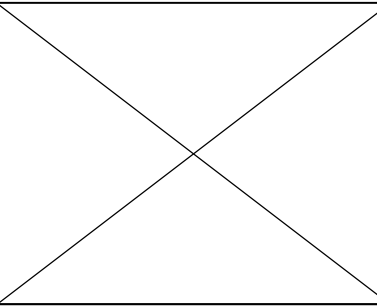
DRAWING REVISION B	REVISION BY S.MUDDA	DATE 22/08/2018
ECO ECO-0151027	APPROVED BY JAY	DATE 22/08/2018
ECO DESCRIPTION OUTLINE UPDATED AS PER NEW 3D STRUCTURING		
<small>COPYRIGHT REGAL BELOIT AMERICA, INC. ALL RIGHTS RESERVED. PROPRIETARY AND CONFIDENTIAL INFORMATION - THIS DOCUMENT IS THE PROPERTY OF REGAL BELOIT AMERICA, INC. ("OWNER") AND CONTAINS OWNER'S PROPRIETARY INFORMATION. ANY PERSON, CORPORATION OR OTHER FIRM RECEIVING IT IS DEEMED, BY RECEIVING IT, TO AGREE THAT IT, AND/OR ANY PART OF IT, SHALL NOT BE DISCLOSED TO ANY PERSON, CORPORATION OR OTHER ENTITY, DUPLICATED, AND/OR USED, EXCEPT AS EXPRESSLY APPROVED IN WRITING IN ADVANCE BY OWNER. THIS DOCUMENT SHALL BE RETURNED TO OWNER UPON REQUEST. IT MAY BE SUBJECT TO CERTAIN RESTRICTIONS UNDER APPLICABLE EXPORT CONTROL LAWS AND REGULATIONS.</small>		



DRAWN BY NIV	 Regal Beloit America, Inc.
DATE 25/03/2016	
APPROVED BY SBD	DESCRIPTION OUTLINE 320T FR-TEFC
DATE 25/03/2016	MATERIAL
REFERENCE	PROCESS/FINISH
THIRD ANGLE PROJECTION	SIZE B
	DRAWING NUMBER SS312782
	SHEET 1 OF 1

4

3

2

1