

THIS DRAWING IS PROPRIETARY TO HHI. NO PART OF THIS DRAWING MAYBE REPRODUCED WITHOUT THE PERMISSION OF HHI.

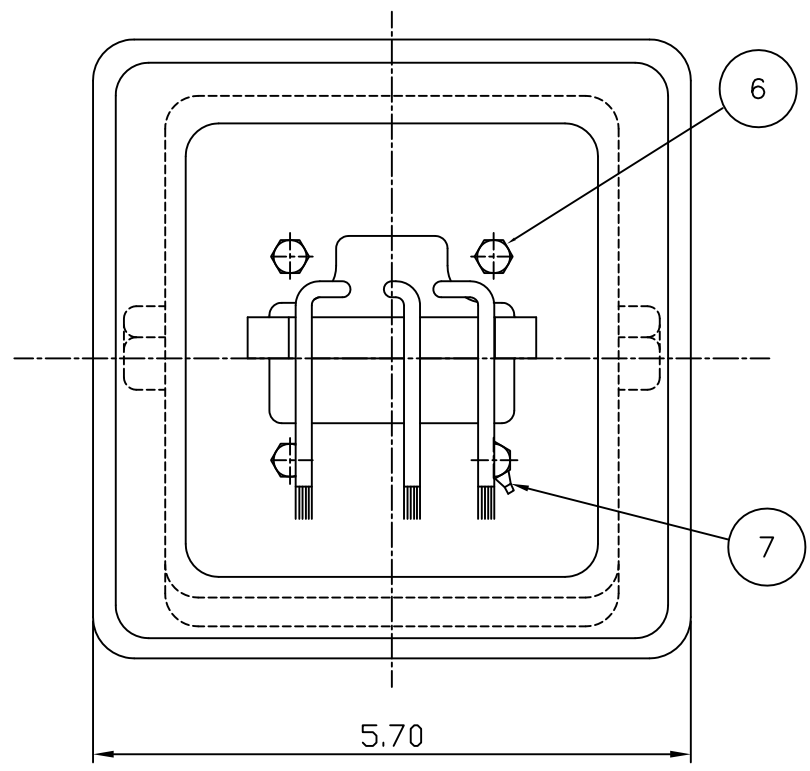

PT	DESCRIPTION	MATERIAL	DIMENSION	Q'TY
1	CONDUIT BOX	FC15	---	1
2	CONDUIT BOX COVER	FC15	---	1
3	O-RING / COVER	EPDM	∅4	1
4	BOX GASKET	NBR	---	1
5	COVER+BOX HEX BOLT	S45C	M6 X L20	4
6	BOX+FRAME HEX BOLT	S45C	M6 X L20	4
7	GROUND TERMINAL LUG	CU	---	1

Q'TY	DESCRIPTION	MATERIAL	DIMENSION	WEIGHT	PART NO.	REMARK	NO.
APPD BY		UNIT	INCH	SUBJECT	NEMA 182/184	CAD PROJ \ FILE	
CHKD BY		SCALE	1:1	227B8008CB2			
CHKD BY	---	PROJEC'N	(3rd Angle)	TITLE			
DSND BY	JEONG JIN SEON	DATE	2007.04.28.	TERMINAL BOX ASSEMBLY			
REF. NO		227B8004NA1		Sheet No.		of	
DWG NO		227B8004NA1		Revision No.		0	

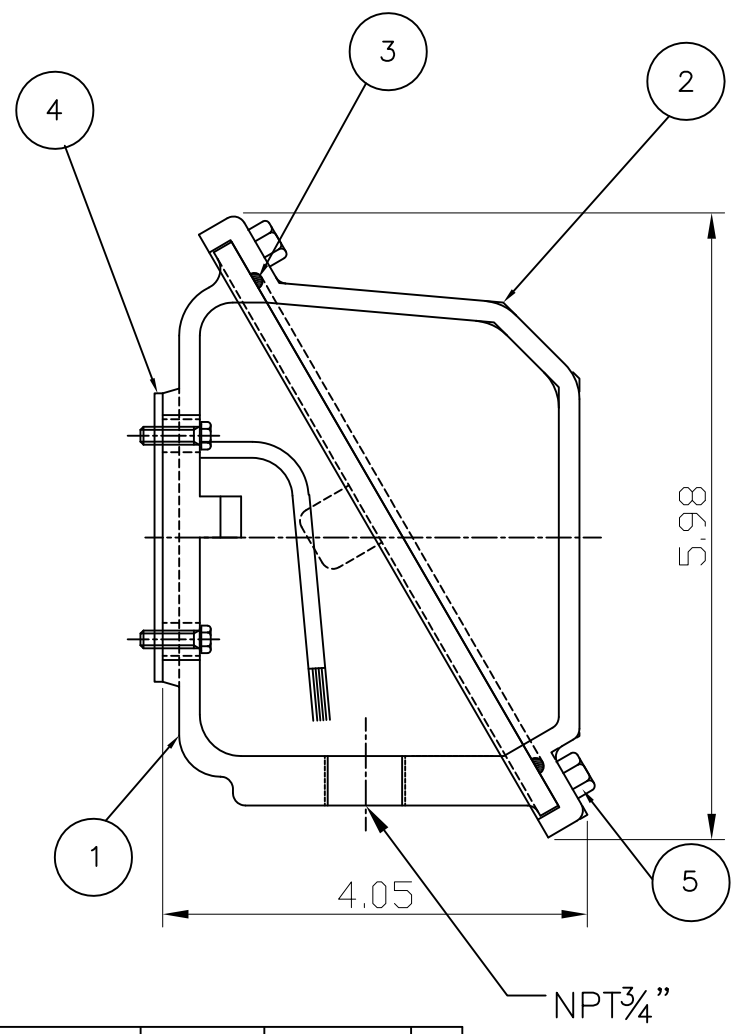

REV	DATE	CONTENTS	REVD BY	CHKD BY	CHKD BY	APPD BY