



TEFC

THREE PHASE INDUCTION MOTOR

TYPE

KP,IP

CAST IRON FRAME

FRAME SIZE

OUTPUT(HP)

POLES

Hz

TIME RATING

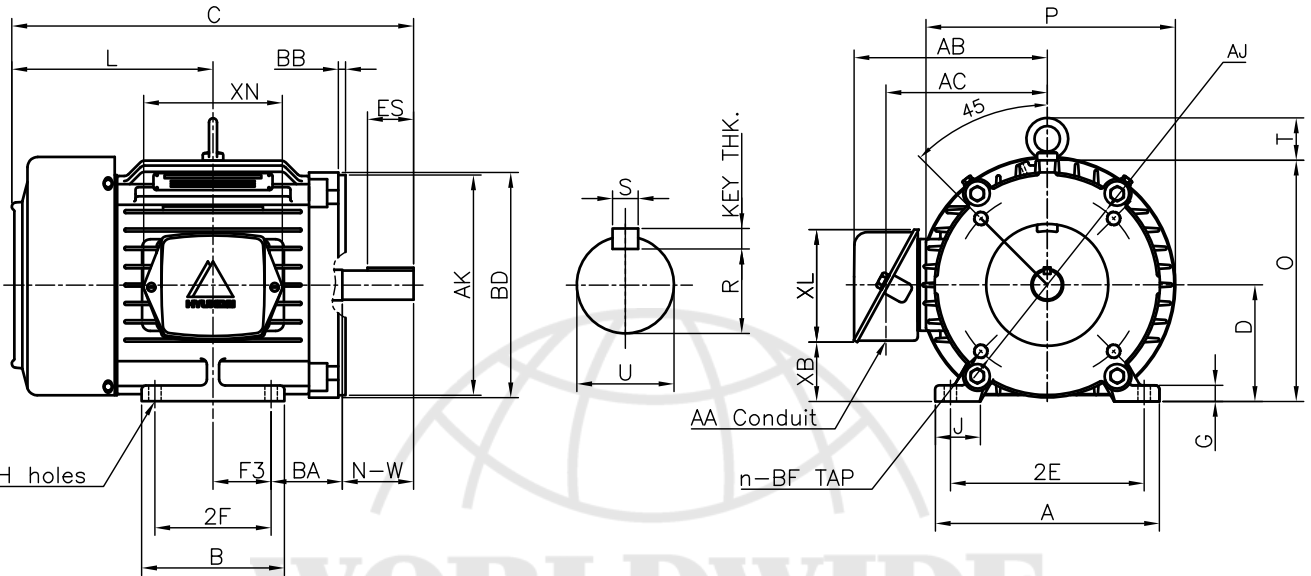

DIMENSIONS

FLANGE						MOUNTING								
AJ	AK	BD	BB	BF	n	A	B	2E	2F	-	F3	G	J	H
7.250	8.50	8.70	0.25	1/2-13	4	8.66	6.54	7.50	4.50	-	2.75	0.62	1.74	0.41

CONDUIT BOX						OVERALL							APPROX. WGT.(LB)
AA	AB	AC	XB	XL	XN	BA	C	D	L	O	P	T	
0.75	7.47	6.23	3.03	4.35	5.35	2.75	15.52	4.50	7.78	9.32	9.64	1.63	90

SHAFT					KEY THK.	BEARING	
U	N-W	KEYWAY				DRIVE END	OPP. DRIVE END
		R	ES	S			
1.125	2.75	0.986	1.78	0.250	0.250	6206ZZC3	6206ZZC3

NOTE

- 1.Dimension "D" tolerance : +0.00inch - 0.03inch
- 2.Dimension "U" tolerance : +0.000inch - 0.0005inch
- 3.Dimension "R" tolerance : +0.000inch - 0.015inch

APPD BY	J.H.KIM	UNIT	INCH	SUBJECT	NEMA 182TC(KIT)	CAD PROJ	FILE	
CHKD BY	N.D.LEE	SCALE	1/8			SCALE-NEMA\A1303AA		
CHKD BY	K.S.LEE	PROJEC'N	3rd Angle	TITLE				OUTLINE
DSND BY	S.W.SEO	DATE	2010.12.20					
				REF. NO	350A1303AA	Sheet No. of		
				DWG NO	350A1303AA	Revision No. 0		