



TEFC

THREE PHASE INDUCTION MOTOR

TYPE

KP,IP

CAST IRON FRAME

FRAME SIZE

OUTPUT(HP)

POLES

Hz

TIME RATING

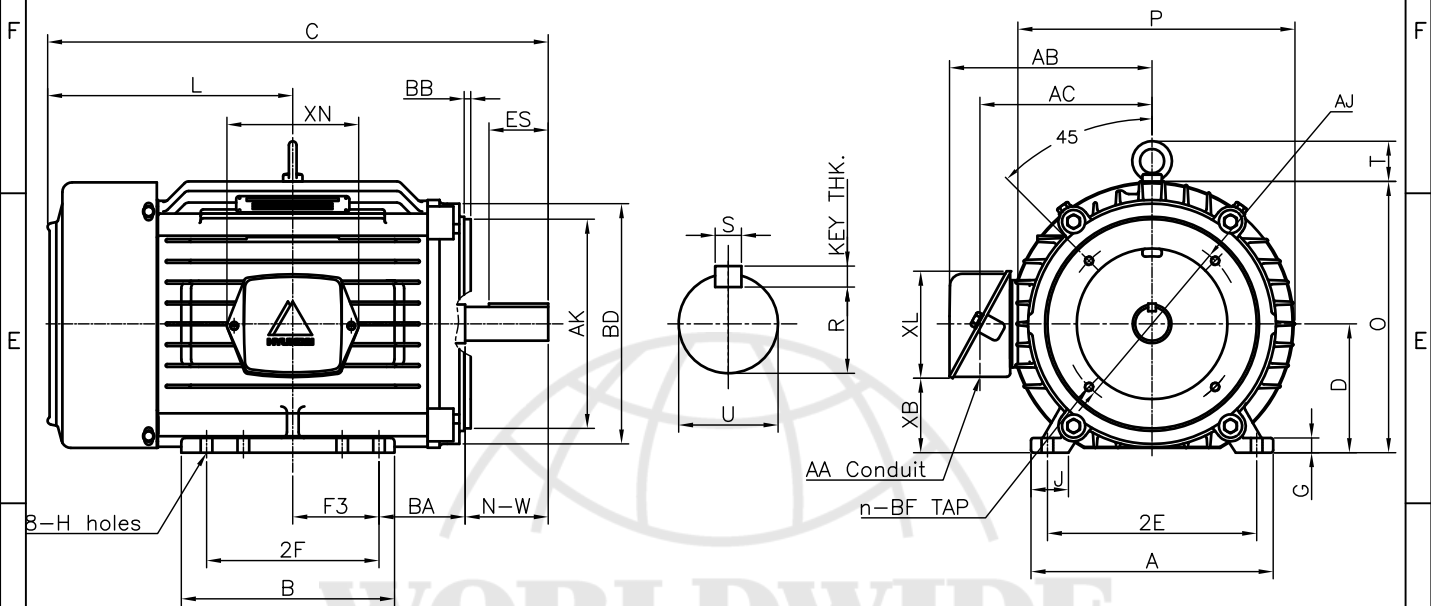

DIMENSIONS

FLANGE						MOUNTING								
AJ	AK	BD	BB	BF	n	A	B	2E	2F	-	F3	G	J	H
7.25	8.50	9.00	0.25	1/2-13	4	9.84	8.66	8.50	7.00	-	3.50	0.60	1.52	0.41

CONDUIT BOX						OVERALL							APPROX. WGT.(LB)
AA	AB	AC	XB	XL	XN	BA	C	D	L	O	P	T	
1.00	8.23	7.34	3.03	4.35	5.35	3.50	20.36	5.25	9.97	11.02	11.26	1.63	165

SHAFT					KEY THK.	BEARING	
U	N-W	KEYWAY				DRIVE END	OPP. DRIVE END
		R	ES	S			
1.375	3.38	1.201	2.41	0.312	0.312	6307ZZC3	6307ZZC3

NOTE

- 1.Dimension "D" tolerance : +0.00inch - 0.03inch
- 2.Dimension "U" tolerance : +0.000inch - 0.0005inch
- 3.Dimension "R" tolerance : +0.000inch - 0.015inch

APPD BY	J.H.KIM	UNIT	INCH	SUBJECT	NEMA 215TC(KIT)	CAD PROJ	FILE	
CHKD BY	N.D.LEE	SCALE	1/8			SCALE-NEMA\A1306AA		
CHKD BY	K.S.LEE	PROJEC'N	3rd Angle	TITLE				OUTLINE
DSND BY	S.W.SEO	DATE	2010.12.20					



REF. NO	350A1306AA	Sheet No.	of
DWG NO	350A1306AA	Revision No.	0