



TEFC

THREE PHASE INDUCTION MOTOR

TYPE

KP,IP

CAST IRON FRAME

FRAME SIZE

OUTPUT(HP)

POLES

Hz

TIME RATING

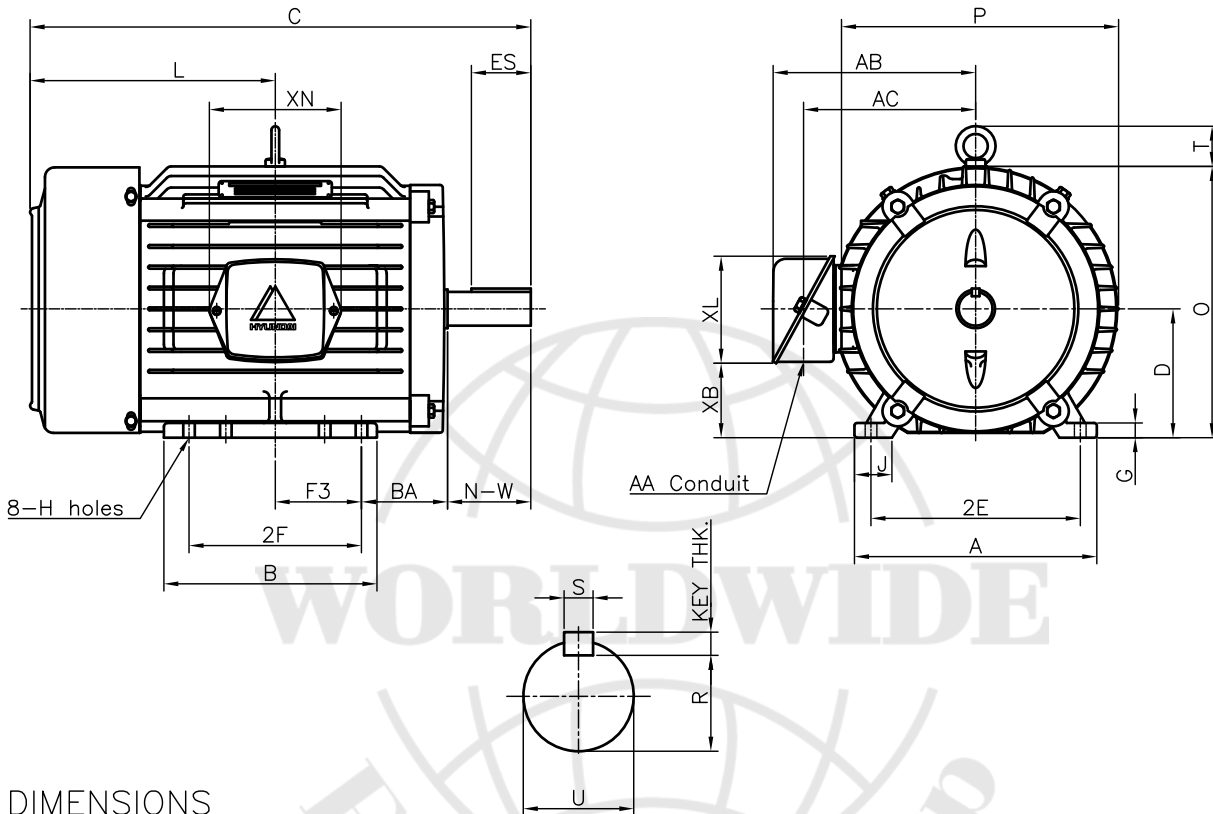

DIMENSIONS

MOUNTING									CONDUIT BOX						APPROX. WGT.(LB)
A	B	2E	2F	-	F3	G	J	H	AA	AB	AC	XB	XL	XN	
9.84	8.66	8.50	7.00	-	3.50	0.60	1.52	0.41	1.00	8.23	7.34	3.03	4.35	5.35	165

OVERALL							SHAFT			KEY THK.	BEARING			
BA	C	D	L	O	P	T	U	N-W	KEYWAY			DRIVE END	OPP. DRIVE END	
									R	ES	S			
3.50	20.36	5.25	9.97	11.02	11.26	1.63	1.375	3.38	1.201	2.41	0.312	0.312	6307ZZC3	6307ZZC3

NOTE

- 1.Dimension "D" tolerance : +0.00inch - 0.03inch
- 2.Dimension "U" tolerance : +0.000inch - 0.0005inch
- 3.Dimension "R" tolerance : +0.000inch - 0.015inch

APPD BY	J.H.KIM	UNIT	INCH	SUBJECT	NEMA 215T	CAD PROJ	\ FILE	
CHKD BY	N.D.LEE	SCALE	1/8			SCALE-NEMA\A1106AA		
CHKD BY	K.S.LEE	PROJEC'N	3rd Angle	TITLE				OUTLINE
DSND BY	S.W.SEO	DATE	2010.12.20					

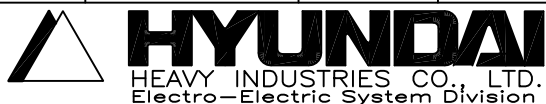

REF. NO	350A1106AA	Sheet No.	of
DWG NO	350A1106AA	Revision No.	0