



TEFC

THREE PHASE INDUCTION MOTOR

TYPE

LP,JP

CAST IRON FRAME

FRAME SIZE

OUTPUT(HP)

POLES

Hz

TIME RATING

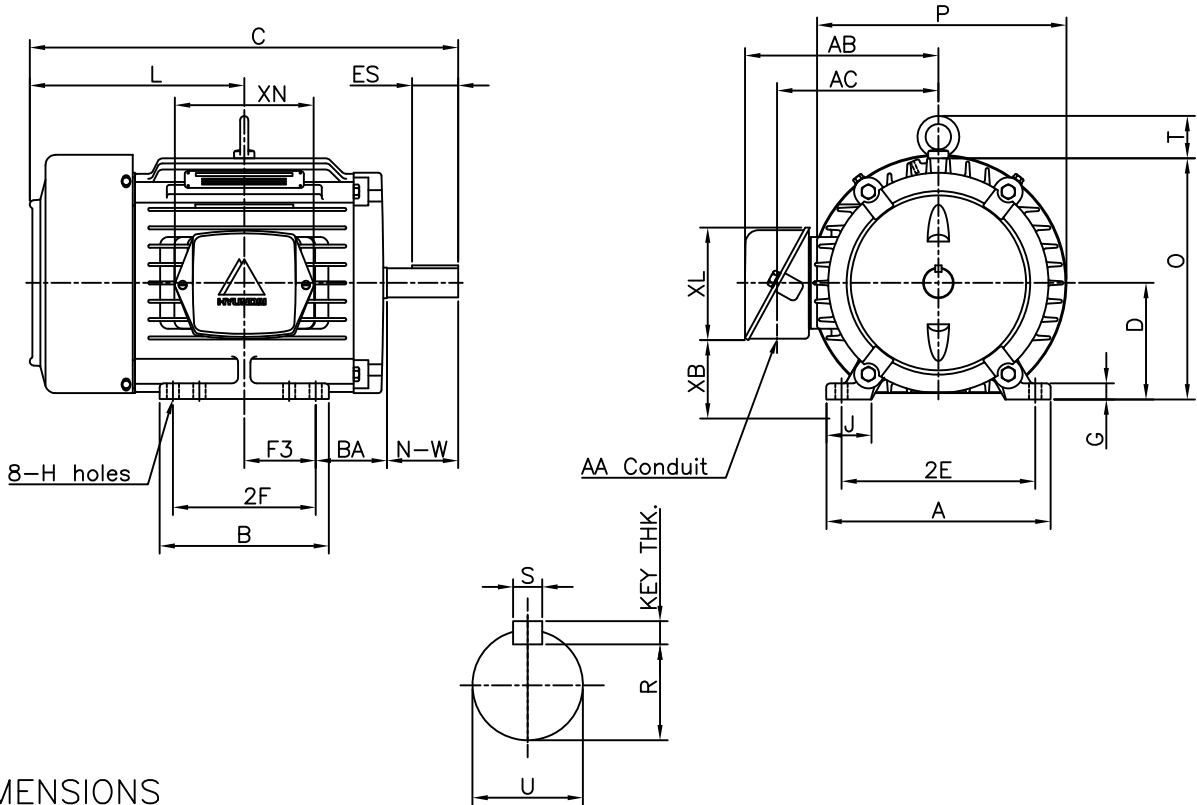

DIMENSIONS

MOUNTING									CONDUIT BOX						APPROX. WGT.(LB)
A	B	2E	2F	-	F3	G	J	H	AA	AB	AC	XB	XL	XN	
8.66	6.54	7.50	5.50	-	2.75	0.62	1.74	0.41	0.75	7.47	6.23	3.03	4.35	5.35	105

OVERALL							SHAFT					KEY THK.	BEARING	
BA	C	D	L	O	P	T	U	N-W	KEYWAY				DRIVE END	OPP. DRIVE END
									R	ES	S			
2.75	16.55	4.50	8.29	9.32	9.64	1.63	1.125	2.75	0.986	1.78	0.250	0.250	6206ZZC3	6206ZZC3

NOTE

- 1.Dimension "D" tolerance : +0.00inch - 0.03inch
- 2.Dimension "U" tolerance : +0.000inch - 0.0005inch
- 3.Dimension "R" tolerance : +0.000inch - 0.015inch

APPD BY	J.H.KIM	UNIT	INCH	SUBJECT	NEMA 184T	CAD PROJ \ FILE
CHKD BY	N.D.LEE	SCALE	1/8			SCALE-NEMA\A1104AA
CHKD BY	K.S.LEE	PROJEC'N	3rd Angle	TITLE	OUTLINE	
DSND BY	S.W.SEO	DATE	2010.12.20			
				REF. NO	350A1104AA	Sheet No. of
				DWG NO	350A1104AA	Revision No. 0