



WORLDWIDE ELECTRIC MOTOR DATA SHEET

IXPEWWE3-18-182T



HORSEPOWER	3		
RPM / POLES	1800 / 4		
VOLTAGE / PHASE	230 / 460 V / 3		
FRAME	182T		
ENCLOSURE / DEGREE OF PROTECTION	TEFC / IP55		
FREQUENCY	60 HZ Suitable For 50 HZ Operation With 1.0 SF		
FULL LOAD SPEED	1773 RPM		
SERVICE FACTOR	1.15 SF		
INSULATION CLASS	F		
FULL LOAD AMPS	7.6 / 3.8 A		
LOCKED ROTOR AMPS (STARTING)	64.0 / 32.0 A		
NO LOAD CURRENT			
NEMA CODE LETTER	K		
EFFICIENCY / POWER FACTOR	<u>LOAD</u>	<u>EFF.</u>	<u>P.F.</u>
	100%	89.5%	0.77
	75%	89.0%	0.71
	50%	87.5%	0.60
DUTY CYCLE	S1 / Continuous		
TORQUE	<u>FULL LOAD</u>	<u>LRT</u>	<u>BDT</u>
	8.9 lb.ft.	215%	250%
SLIP	1.50%		
NEMA DESIGN	B		
MOMENT OF INERTIA			
NUMBER OF STARTS (Hot / Cold)	1 Hot / 2 Cold (Per Hour)		
MAX. AMBIENT TEMPERATURE	40° C		
MAX. ELEVATION	3300 Ft. Above Sea Level		
TEMPERATURE RISE (At Full Load)	80° C		
DE BEARING	6306-ZZ		
ODE BEARING	6306-ZZ		
GREASE TYPE	Mobil Polyrex EM		
MOUNTING	F1		
ROTATION	Bi-Directional		
APPROXIMATE WEIGHT	130 lbs.		
TEMPERATURE CODE AT 40°C AMBIENT	T3C		
TEMPERATURE CODE AT 55°C AMBIENT	T3C		
AREA CLASSIFICATION	Class I, Division I, Groups C & D		
	Class II, Division I, Groups F & G		
INVERTER RATING	5:1 CT / 10:1 VT PWM Type		





WORLDWIDE ELECTRIC MOTOR DRAWING

IXPEWWE-145T

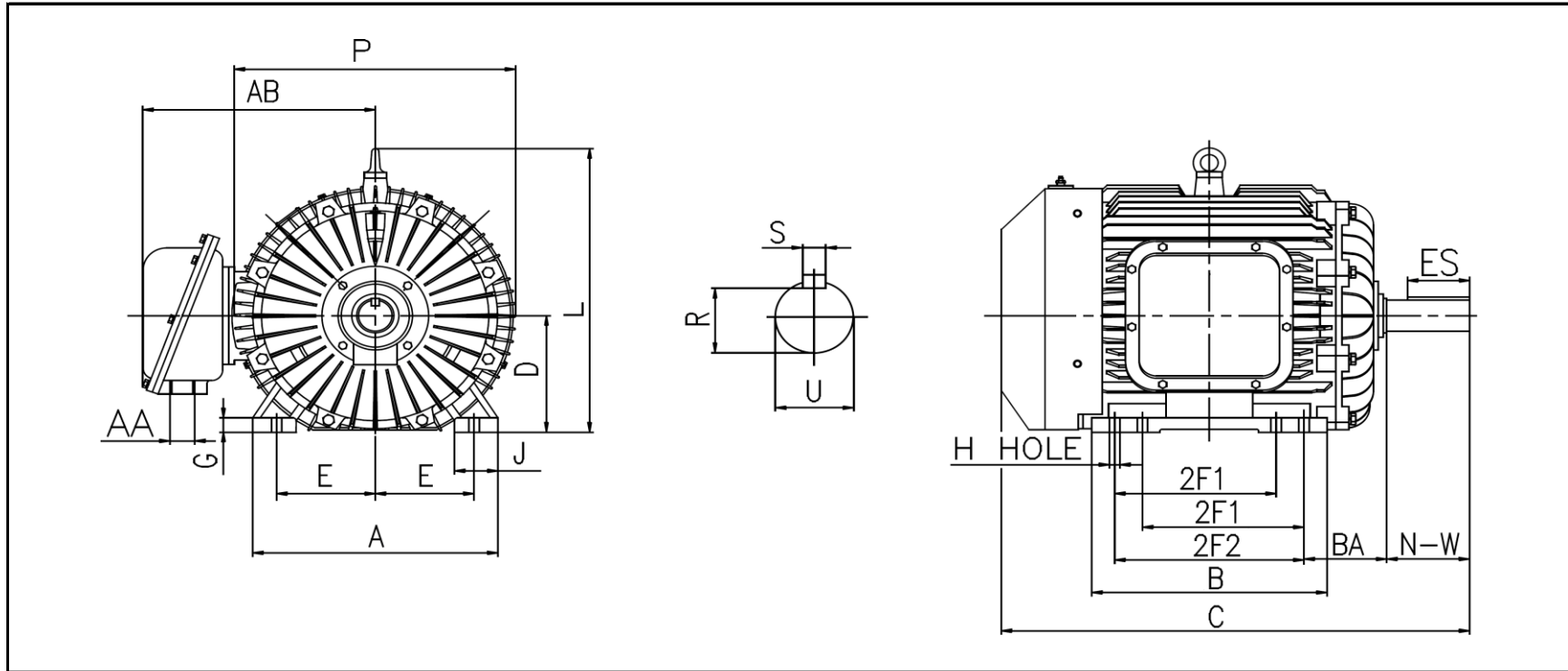

MOUNTING					A	B	C	D	G	J
E	2F1	2F2	H	BA						
2.75	4	5	0.34	2.25	6.9	6.89	15.35	3.5	0.47	1.42

L	P	AA	AB	KEY	KEYSEAT	SHAFT	N-W	U
				ES	S	R		
9.25	7.56	3/4	8.07	1.46	0.188	0.771	2.25	0.875

ALL DIMENSIONS IN INCHES

REVISED - 09/16/16