



WORLDWIDE ELECTRIC MOTOR DATA SHEET

IXPEWWE2-36-145T



HORSEPOWER	2		
RPM / POLES	3600 / 2		
VOLTAGE / PHASE	230 / 460 V / 3		
FRAME	145T		
ENCLOSURE / DEGREE OF PROTECTION	TEFC / IP55		
FREQUENCY	60 HZ Suitable For 50 HZ Operation With 1.0 SF		
FULL LOAD SPEED	3504 RPM		
SERVICE FACTOR	1.15 SF		
INSULATION CLASS	F		
FULL LOAD AMPS	5.0 / 2.5 A		
LOCKED ROTOR AMPS (STARTING)	50.0 / 25.0 A		
NO LOAD CURRENT			
NEMA CODE LETTER	L		
EFFICIENCY / POWER FACTOR	<u>LOAD</u>	<u>EFF.</u>	<u>P.F.</u>
	100%	85.5%	0.86
	75%	86.0%	0.83
	50%	85.3%	0.73
DUTY CYCLE	S1 / Continuous		
TORQUE	<u>FULL LOAD</u>	<u>LRT</u>	<u>BDT</u>
	3.0 lb.ft.	170%	240%
SLIP	2.67%		
NEMA DESIGN	B		
MOMENT OF INERTIA			
NUMBER OF STARTS (Hot / Cold)	1 Hot / 2 Cold (Per Hour)		
MAX. AMBIENT TEMPERATURE	40° C		
MAX. ELEVATION	3300 Ft. Above Sea Level		
TEMPERATURE RISE (At Full Load)	80° C		
DE BEARING	6205-ZZ		
ODE BEARING	6205-ZZ		
GREASE TYPE	Mobil Polyrex EM		
MOUNTING	F1		
ROTATION	Bi-Directional		
APPROXIMATE WEIGHT	75 lbs.		
TEMPERATURE CODE AT 40°C AMBIENT	T3C		
TEMPERATURE CODE AT 55°C AMBIENT	T3C		
AREA CLASSIFICATION	Class I, Division I, Groups C & D		
	Class II, Division I, Groups F & G		
INVERTER RATING	5:1 CT / 10:1 VT PWM Type		





WORLDWIDE ELECTRIC MOTOR DRAWING

IXPEWWE-182T

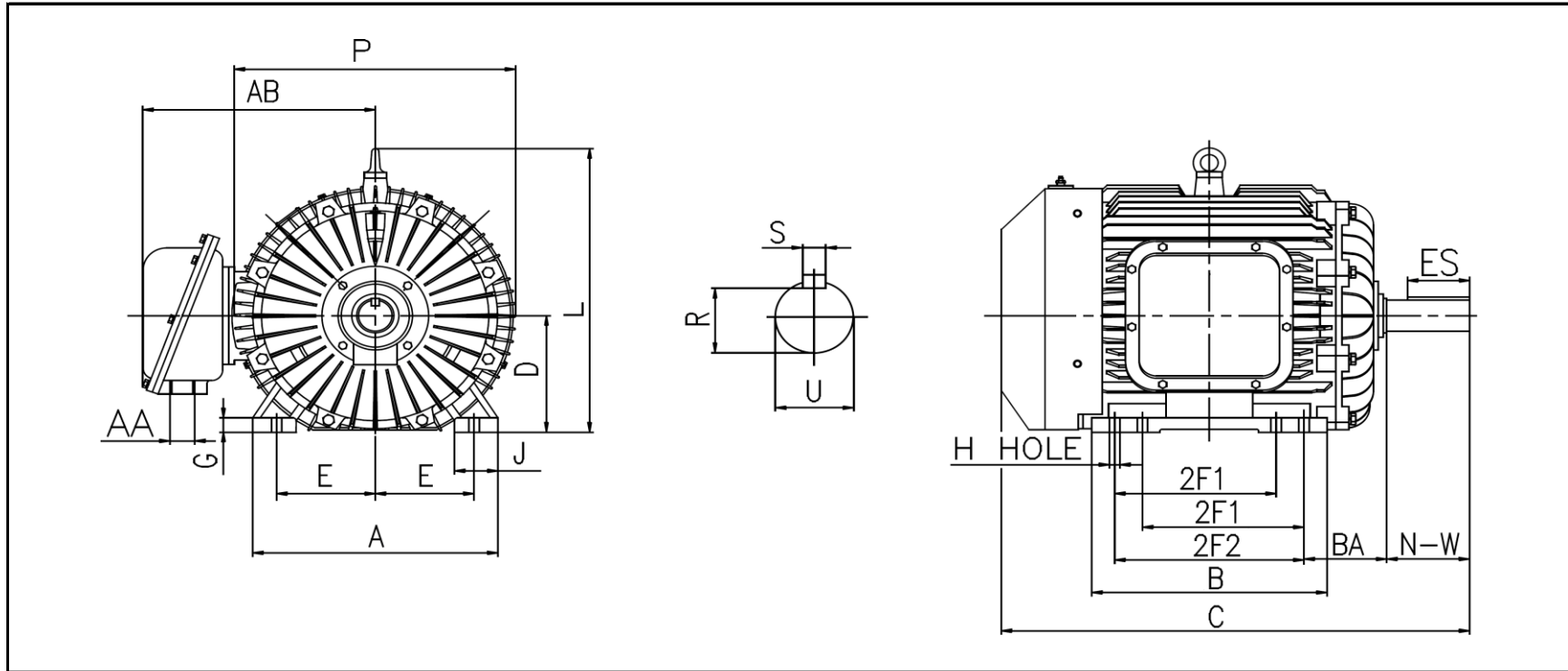

MOUNTING					A	B	C	D	G	J
E	2F1	2F2	H	BA						
3.75	4.5	5.5	0.41	2.75	8.86	7.87	18.42	4.5	0.67	1.69

L	P	AA	AB	KEY	KEYSEAT	SHAFT	N-W	U
				ES	S	R		
11.4	9.84	0.75	9.06	1.78	0.25	0.986	2.75	1.125

ALL DIMENSIONS IN INCHES

REVISED - 09/16/16