



# WORLDWIDE ELECTRIC MOTOR DATA SHEET



## PEWWE250-12-586/7

HORSEPOWER	250		
RPM / POLES	1200 / 6		
VOLTAGE / PHASE	460 V / 3		
FRAME	586/7T		
ENCLOSURE / DEGREE OF PROTECTION	TEFC / IP55		
FREQUENCY	60 HZ		
FULL LOAD SPEED	1190 RPM		
SERVICE FACTOR	1.15		
INSULATION CLASS	F		
FULL LOAD AMPS	287 A		
LOCKED ROTOR AMPS (STARTING)	1825 A		
NO LOAD CURRENT	112 A		
NEMA CODE LETTER	G		
EFFICIENCY / POWER FACTOR	<u>LOAD</u>	<u>EFF.</u>	<u>P.F.</u>
	100%	95.8%	0.85
	75%	95.8%	0.82
	50%	95.4%	0.72
DUTY CYCLE	CONTINUOUS		
TORQUE	<u>FULL LOAD</u>	<u>LRT</u>	<u>BDT</u>
	1103 lb.ft.	200%	250%
SLIP	0.83%		
NEMA DESIGN	B		
MOMENT OF INERTIA	178 lb.ft. <sup>2</sup>		
SOUND PRESSURE LEVEL	87 dB(A)		
MAX. TIME LOCKED ROTOR (Hot)	13 Seconds		
MAX. AMBIENT TEMPERATURE	40° C		
MAX. ELEVATION	3300 Ft. Above Sea Level		
TEMPERATURE RISE (At Full Load)	80° C		
DE BEARING	NU326 C3		
ODE BEARING	6324 C3		
REGREASING INT. - DE BEARING	1,500 Hours		
REGREASING INT. - ODE BEARING	2,200 Hours		
GREASE TYPE	Mobil Polyrex EM		
MOUNTING	F1		
ROTATION	Bi-Directional		
CONNECTION DIAGRAM	460 V - 6 Lead Δ		
SHAFT MATERIAL	4140 Carbon Steel		
APPROX. WEIGHT	3737 lbs.		
INVERTER RATING	3:1 CT / 6:1 VT PWM Type		



CC006A





# WORLDWIDE ELECTRIC MOTOR DRAWING

## PEWWE-586/7-6P,8P

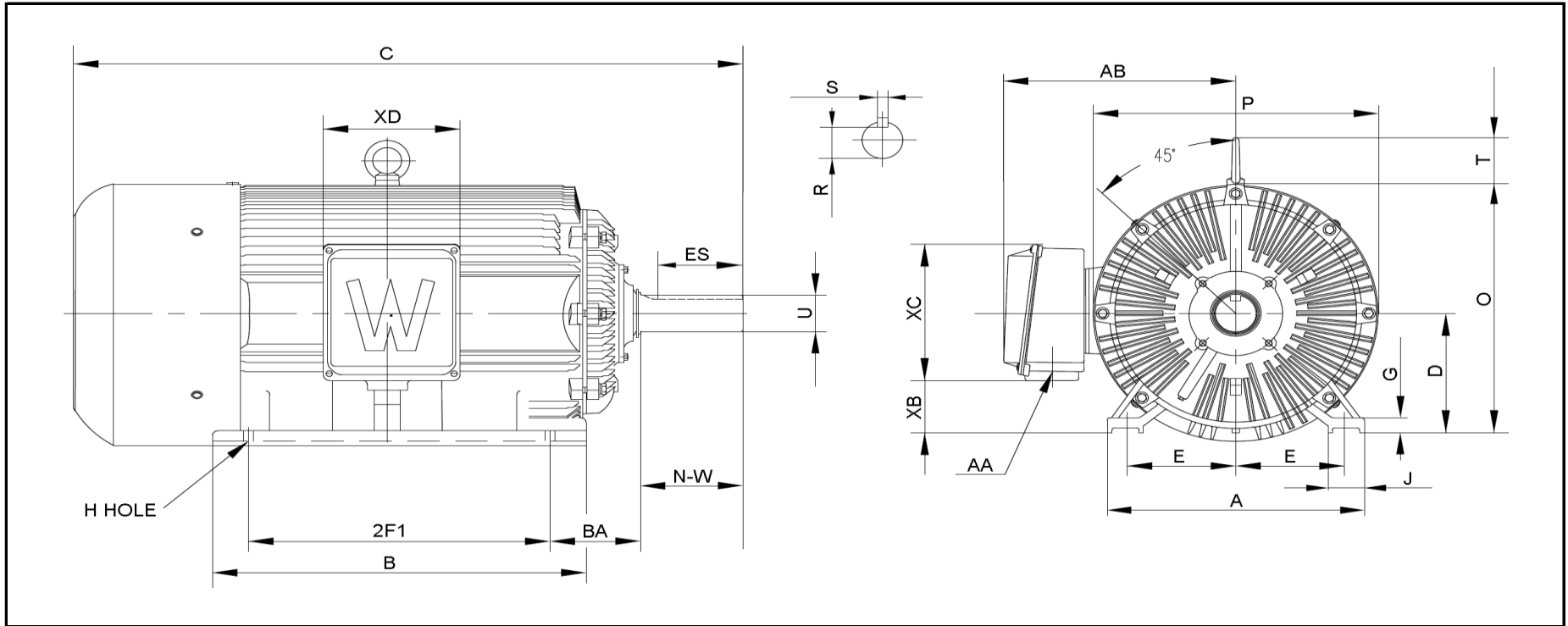

**DIMENSIONS - INCHES**

MOUNTING					A	B	C	D	G	J	P	O	T	AB
E	2F1	2F2	H	BA										
11.5	22	25	1.125	10	28	33.85	66	14.5	2.05	5	30.5	28.9	5	25

KEY		KEYSET	SHAFT		TERMINAL BOX				
S	ES	R	N-W	U	AA	XB	XC	XD	XE
1	10	3.309	11.625	3.875	2 x 3"	5	16.5	14.5	---