



WORLDWIDE ELECTRIC MOTOR DATA SHEET



PEWWE2-36-145JM

HORSEPOWER	2		
RPM / POLES	3600 / 2		
VOLTAGE / PHASE	230 / 460 V / 3		
FRAME	145JM		
ENCLOSURE / DEGREE OF PROTECTION	TEFC / IP54		
FREQUENCY	60 HZ Suitable For 50 HZ Operation With 1.0 SF		
FULL LOAD SPEED	3490 RPM		
SERVICE FACTOR	1.15		
INSULATION CLASS	F		
FULL LOAD AMPS; 230 / 460	5.21 / 2.61 A (Usable On 208V At 5.76 A)		
LOCKED ROTOR AMPS (STARTING); 230 / 460	50.0 / 25.0 A		
NO LOAD CURRENT	2.5 / 1.25 A		
NEMA CODE LETTER	L		
EFFICIENCY / POWER FACTOR	<u>LOAD</u>	<u>EFF.</u>	<u>P.F.</u>
	100%	85.5%	0.84
	75%	86.0%	0.78
	50%	85.7%	0.67
DUTY CYCLE	CONTINUOUS		
TORQUE	<u>FULL LOAD</u>	<u>LRT</u>	<u>BDT</u>
	3.01 lb.ft.	230%	320%
SLIP	3.05%		
NEMA DESIGN	B		
MOMENT OF INERTIA	0.05 lb.ft. ²		
MAX. TIME LOCKED ROTOR (Hot)	6 Seconds		
SOUND PRESSURE LEVEL	62 dB(A)		
MAX. AMBIENT TEMPERATURE	40° C		
MAX. ELEVATION	3300 Ft. Above Sea Level		
TEMPERATURE RISE (At Full Load)	80° C		
DE BEARING	6206ZZ C3		
ODE BEARING	6205ZZ C3		
REGREASING INT. - DE BEARING	---		
REGREASING INT. - ODE BEARING	---		
GREASE TYPE	Mobil Polyrex EM		
MOUNTING	F1		
ROTATION	Bi-Directional		
SHAFT MATERIAL	1045 Carbon Steel		
CONNECTION DIAGRAM	230 / 460 V - 9 Lead Y		
APPROXIMATE WEIGHT	51 lbs.		



CC006A





WORLDWIDE ELECTRIC MOTOR DRAWING

PEWWE-145JM

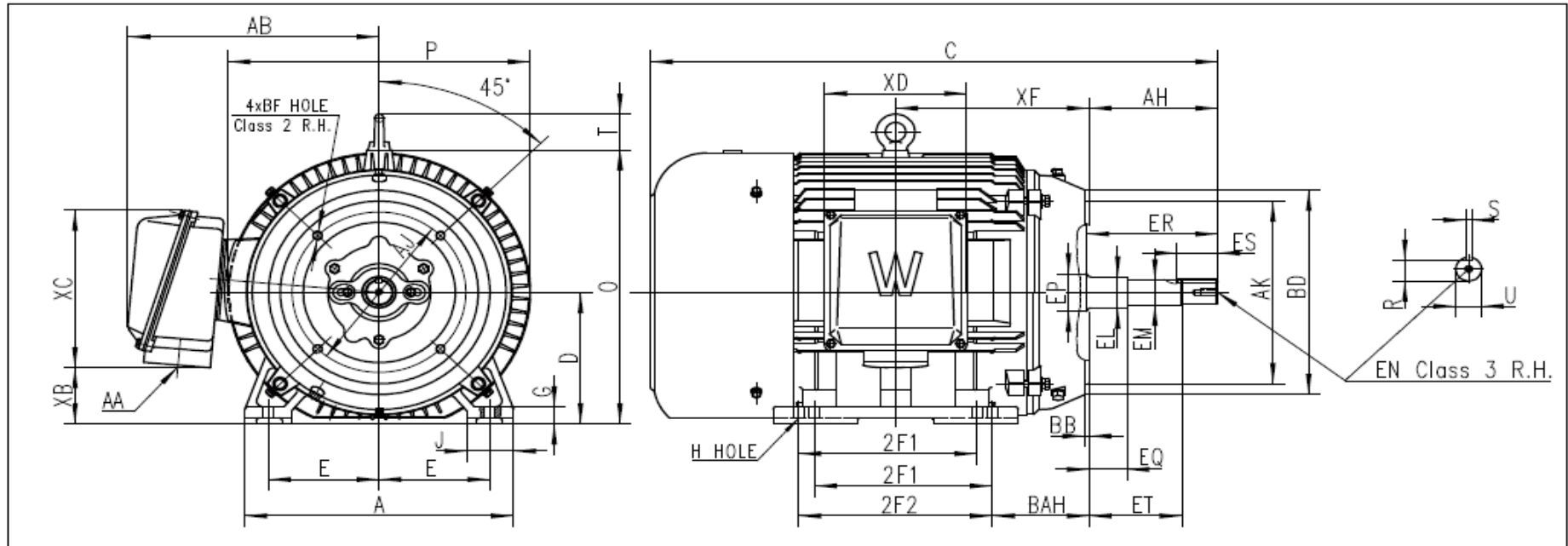

DIMENSIONS - INCHES

MOUNTING					A	B	C	D	G	J	P	O	T	AH	AB	KEY			KEYSET
E	2F1	2F2	H	BAH												S	ES	R	
2.75	4	5	0.34	2.87	7	6.6	16	3.5	0.43	1	7.8	7.6	1.42	4.25	6.7	0.188	1.65	0.768	

FLANGE					SHAFT EXTENSION								AA	XB	XC	XD	XF
AK	AJ	BF	BB	BD	EQ	ET	EM	EL	EP	ER	EN	U					
4.5	5.875	3/8-16	0.156	6.6	0.625	2.875	1	1.155	1.181	4.37	3/8-16	0.874	3/4	1.6	4.6	4.1	5.37