

**PE405T-75-6-575V**

**GENERAL PURPOSE ELECTRIC MOTOR**

**NEMA PREMIUM EFFICIENCY**

**TOTALLY ENCLOSED FAN COOLED**

**INVERTER DUTY 10:1 CT; 20:1 VT - NEMA MG1 PART 31**

Factory Certified for T2B Class I, Division II, Groups A,B,C & D and Class II, Division II, Groups F & G

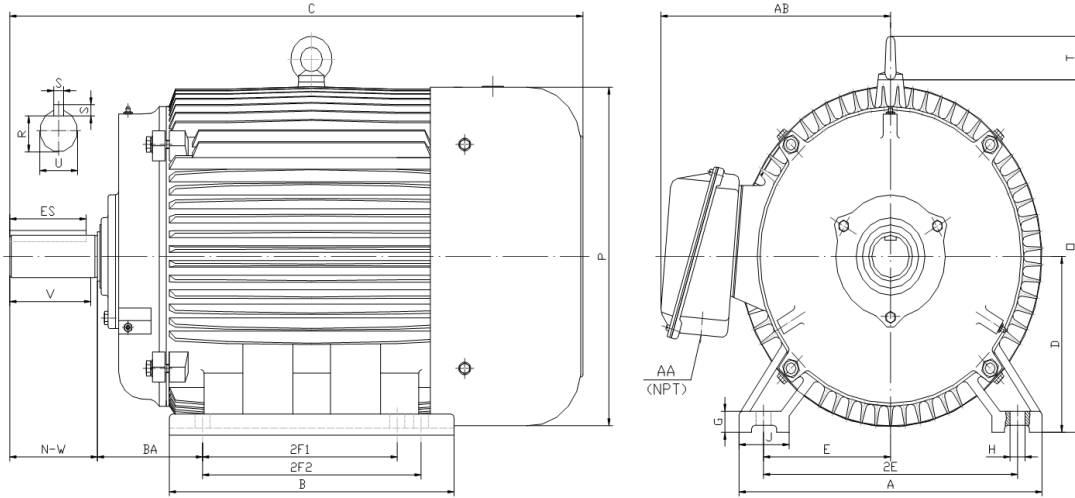

**DIMENSIONS**

HP	RPM	Frame	MOUNTING														
			A	B	C	D	G	H	J	E	2E	2F1	2F2	O	P	T	BA
75	1200	405T	19.30	17.90	38.00	10.00	1.25	0.81	3.15	8.00	16.00	12.25	13.75	21.10	21.60	2.60	6.62

Shaft Extension, Key Set						Conduit Box		Bearings		Mount
U	V	R	S	ES	N-W	AA	AB	DE	ODE	
2.88	7.00	2.45	0.75	5.65	7.25	3.00	16.60	NU318	6314	F1

**BEARING LUBRICATION:** The bearings come lubricated with Mobil Polyrex EM Polyurea Grease. It is recommended that you add some additional lubrication when the motor is installed.

Three options (brands) for suitable lubrication include, but are not limited to, the following:

- 1.) Mobil Polyrex EM
- 2.) Citco Polyurea MP
- 3.) Conoco Phillips Polytac EP





**PE405T-75-6-575V**

**GENERAL PURPOSE ELECTRIC MOTOR**

**NEMA PREMIUM EFFICIENCY**

**TOTALLY ENCLOSED FAN COOLED**

**INVERTER DUTY 10:1 CT; 20:1 VT - NEMA MG1 PART 31**

Factory Certified for T2B Class I, Division II, Groups A,B,C & D and Class II, Division II, Groups F & G

**PERFORMANCE DATA**

HP	RPM	Frame	Voltage	Frequency (Hz)	Full Load S.F.	Insulation Class	NEMA Design	Slip (%)	NEMA Code	Enclosure Type	IP Rating	Max. Ambient
75	1190	405T	575	60	1.15	F	B	0.8	G	TEFC	55	40° C

Amps (575V)		Efficiency (%)				Power Factor			Torque (ft-lb)			DE Bearing	ODE Bearing	Connection	Weight (lbs.)
FLA	LRA	100%	75%	50%	Min.	100%	75%	50%	FLT	LRT %	BDT %				
69.6	434	94.5	94.8	94.5	93.6	0.830	0.820	0.760	335.0	150	230	NU318	6314	6 Lead Δ	1120

**NAME PLATE**

									<b>CONNECTION DIAGRAM</b>  <b>575 V Delta</b> 			
<b>INVERTER DUTY 20:1 VT; 10:1 CT</b>												
CAT NO:		PE405T-75-6-575V		HP	75	Hz	60	PHASE	3			
VOLTS		575		FLA	69.6		IP RATING		55			
RPM	1190		POWER FACTOR		0.83		DESIGN		B			
FRAME	405T		NEMA NOM EFF		94.5		CODE		G			
DRIVE END BEARING	NU318		NEMA MIN EFF		93.6		S.F.		1.15			
OPP DRIVE END BEARING	6314		MAX AMB		40° C		INS CLASS		F			
ENCL	TEFC		RATING	CONT		SER						
MOTOR WEIGHT	1120	LBS	CONNECTION	6 Lead Δ		LUB:		Mobil Polyrex EM				
General purpose use on industrial machinery installed in damp, dusty or dirty environments. Hernando, Mississippi												CC 082A

**APPLICATIONS:**

General purpose use on pumps, fans, blowers, compressors, conveyors, material handling and other industrial machinery installed in damp, dusty or dirty environments.