

PE365TS-75-2

GENERAL PURPOSE ELECTRIC MOTOR

NEMA PREMIUM EFFICIENCY

TOTALLY ENCLOSED FAN COOLED

INVERTER DUTY 10:1 CT; 20:1 VT - NEMA MG1 PART 31

Factory Certified for T2B Class I, Division II, Groups A,B,C & D and Class II, Division II, Groups F & G

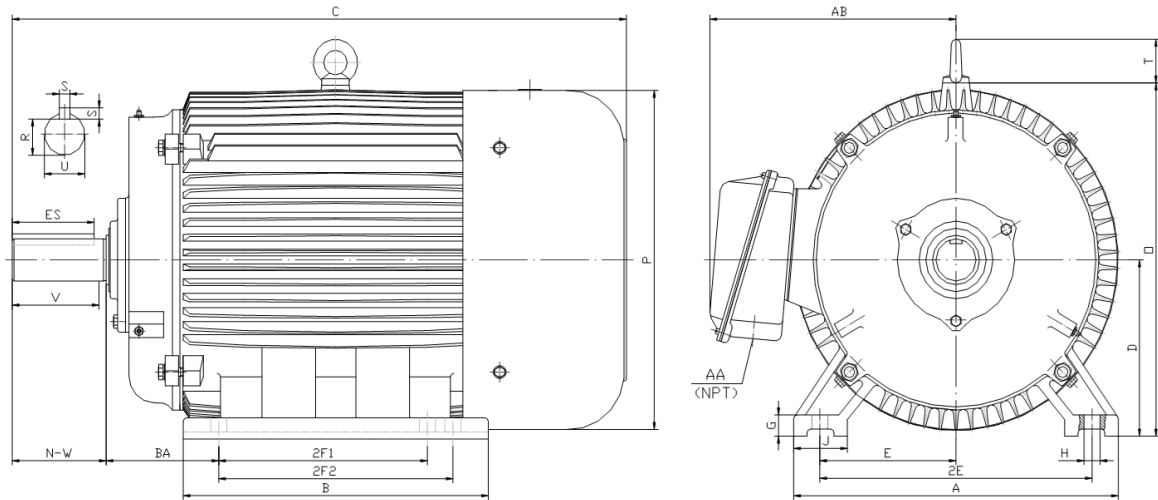

DIMENSIONS

HP	RPM	Frame	MOUNTING														
			A	B	C	D	G	H	J	E	2E	2F1	2F2	O	P	T	BA
75	3600	365TS	17.10	15.40	31.40	9.00	1.15	0.66	2.95	7.00	14.00	11.25	12.25	18.10	17.60	2.60	5.88

Shaft Extension, Key Set						Conduit Box		Bearings		Mount
U	V	R	S	ES	N-W	AA	AB	DE	ODE	
1.875	3.50	1.591	0.500	2.03	3.75	3.00	14.60	6313	6313	F1

BEARING LUBRICATION: The bearings come lubricated with Mobil Polyrex EM Polyurea Grease. It is recommended that you add some additional lubrication when the motor is installed.

Three options (brands) for suitable lubrication include, but are not limited to, the following:

- 1.) Mobil Polyrex EM
- 2.) Citco Polyurea MP
- 3.) Conoco Phillips Polytac EP





PE365TS-75-2

GENERAL PURPOSE ELECTRIC MOTOR

NEMA PREMIUM EFFICIENCY

TOTALLY ENCLOSED FAN COOLED

INVERTER DUTY 10:1 CT; 20:1 VT - NEMA MG1 PART 31







Factory Certified for T2B Class I, Division II, Groups A,B,C & D and Class II, Division II, Groups F & G

PERFORMANCE DATA

HP	RPM	Frame	Voltage	Frequency (Hz)	Full Load S.F.	Insulation Class	NEMA Design	Slip (%)	NEMA Code	Enclosure Type	IP Rating	Max. Ambient
75	3565	365TS	208-230/460	60	1.15	F	B	1.0	G	TEFC	55	40° C

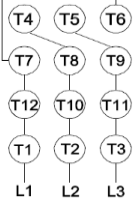
Amps (460V)		Efficiency (%)				Power Factor			Torque (ft-lb)			DE Bearing	ODE Bearing	Connection	Weight (lbs.)
FLA	LRA	100%	75%	50%	Min.	100%	75%	50%	FLT	LRT %	BDT %				
83.0	542	93.6	93.0	92.5	92.4	0.910	0.890	0.840	110.7	130	250	6313	6313	12 Lead 2Δ/Δ	833

NAME PLATE

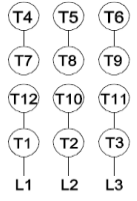
 North American Electric, Inc.													CONNECTION DIAGRAMS 208-230V 										
INVERTER DUTY 20:1 VT; 10:1 CT																							
CAT NO:		PE365TS-75-2				FRAME		365TS		PHASE		3											
HZ		60		S.F.		1.15		HZ		50		S.F.					1.0		ENCL		TEFC		IP
HP		75		RPM		3565		HP		75		RPM		2960		DUTY		CONT		DES		B	
VOLTS				208-230/460				VOLTS				190/380				AMB		40° C		INS		F	
FLA		184 - 166 / 83				FLA				200/100				DE BEARING				6313					
CODE		G		P.F.		0.91		CODE		F		P.F.		0.92		ODE BEARING				6313			
EFF		93.6		MIN		92.4		EFF		92		MIN		90.8		LUB: Mobil Polyrex EM							
MOTOR WEIGHT				833		LBS		CONNECTION				12 Lead 2Δ/Δ		SER NO									
General purpose use on industrial machinery installed in damp, dusty or dirty environments. Hernando, Mississippi																CC 082A		460V 					

APPLICATIONS:

General purpose use on pumps, fans, blowers, compressors, conveyors, material handling and other industrial machinery installed in damp, dusty or dirty environments.