

PE145T-1-6

GENERAL PURPOSE ELECTRIC MOTOR

NEMA PREMIUM EFFICIENCY

TOTALLY ENCLOSED FAN COOLED

INVERTER DUTY 10:1 CT; 20:1 VT - NEMA MG1 PART 31

Factory Certified for T2B Class I, Division II, Groups A,B,C & D and Class II, Division II, Groups F & G

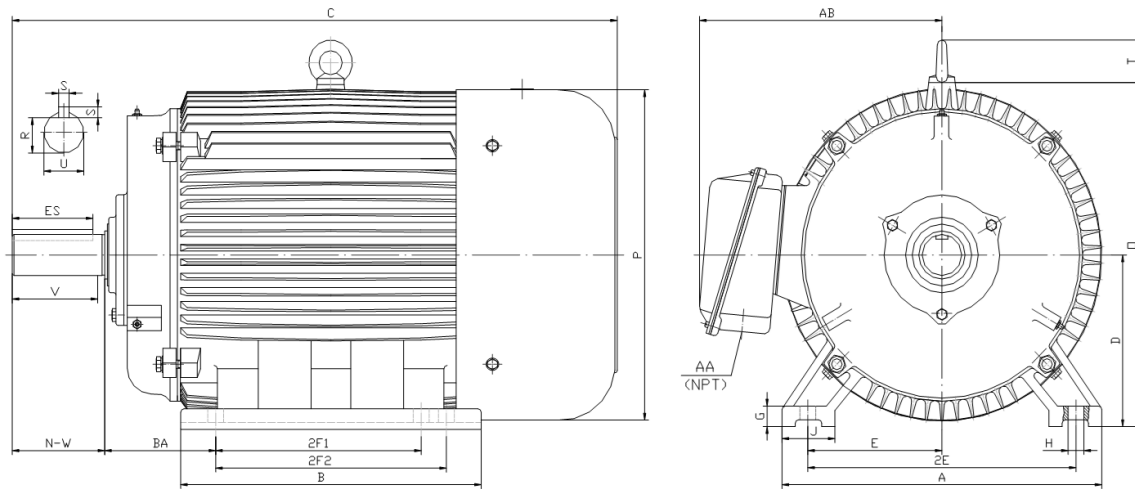

DIMENSIONS

HP	RPM	Frame	MOUNTING														
			A	B	C	D	G	H	J	E	2E	2F1	2F2	O	P	T	BA
1	1200	145T	7.00	6.20	14.60	3.50	0.50	0.34	1.40	2.75	5.50	4.00	5.00	7.10	6.95	0.00	2.25

Shaft Extension, Key Set						Conduit Box		Bearings		Mount
U	V	R	S	ES	N-W	AA	AB	DE	ODE	
0.875	2.00	0.771	0.188	1.41	2.25	0.75	6.10	6205-ZZ	6205-ZZ	F1

BEARING LUBRICATION: The bearings come lubricated with Mobil Polyrex EM Polyurea Grease.





PE145T-1-6

GENERAL PURPOSE ELECTRIC MOTOR

NEMA PREMIUM EFFICIENCY

TOTALLY ENCLOSED FAN COOLED

INVERTER DUTY 10:1 CT; 20:1 VT - NEMA MG1 PART 31







Factory Certified for T2B Class I, Division II, Groups A,B,C & D and Class II, Division II, Groups F & G

PERFORMANCE DATA

HP	RPM	Frame	Voltage	Frequency (Hz)	Full Load S.F.	Insulation Class	NEMA Design	Slip (%)	NEMA Code	Enclosure Type	IP Rating	Max. Ambient
1	1160	145T	208-230/460	60	1.15	F	B	3.3	M	TEFC	55	40° C

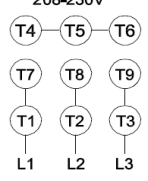
Amps (460V)		Efficiency (%)				Power Factor			Torque (ft-lb)			DE Bearing	ODE Bearing	Connection	Weight (lbs.)
FLA	LRA	100%	75%	50%	Min.	100%	75%	50%	FLT	LRT %	BDT %				
1.8	15	82.5	81.0	79.0	80.0	0.620	0.540	0.430	4.6	200	290	6205-ZZ	6205-ZZ	9 Lead 2Y/Y	53

NAME PLATE

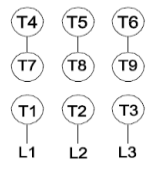
 North American Electric, Inc.															CONNECTION DIAGRAMS 208-230V 		
INVERTER DUTY 20:1 VT; 10:1 CT																	
CAT NO:		PE145T-1-6				FRAME		145T		PHASE		3					
HZ	60	S.F.	1.15	HZ	50	S.F.	1.0	ENCL	TEFC	IP	55						
HP	1	RPM	1160	HP	1	RPM	950	DUTY	CONT	DES	B						
VOLTS		208-230/460				VOLTS		190/380		AMB	40° C	INS	F				
FLA		4 - 3.6 / 1.8				FLA		4.0/2.0		DE BEARING		6205-ZZ					
CODE	M	P.F.	0.62	CODE	K	P.F.	0.69	ODE BEARING		6205-ZZ							
EFF	82.5	MIN	80.0	EFF	80.5	MIN	78	LUB:		Mobil Polyrex EM							
MOTOR WEIGHT		53 LBS		CONNECTION		9 Lead 2Y/Y		SER NO									
General purpose use on industrial machinery installed in damp, dusty or dirty environments. Hernando, Mississippi										  		CC 082A		460V 			

APPLICATIONS:

General purpose use on pumps, fans, blowers, compressors, conveyors, material handling and other industrial machinery installed in damp, dusty or dirty environments.