

PE449TS-300-2-575V

GENERAL PURPOSE ELECTRIC MOTOR

NEMA PREMIUM EFFICIENCY

TOTALLY ENCLOSED FAN COOLED

INVERTER DUTY 10:1 CT; 20:1 VT - NEMA MG1 PART 31

Factory Certified for T2B Class I, Division II, Groups A,B,C & D and Class II, Division II, Groups F & G

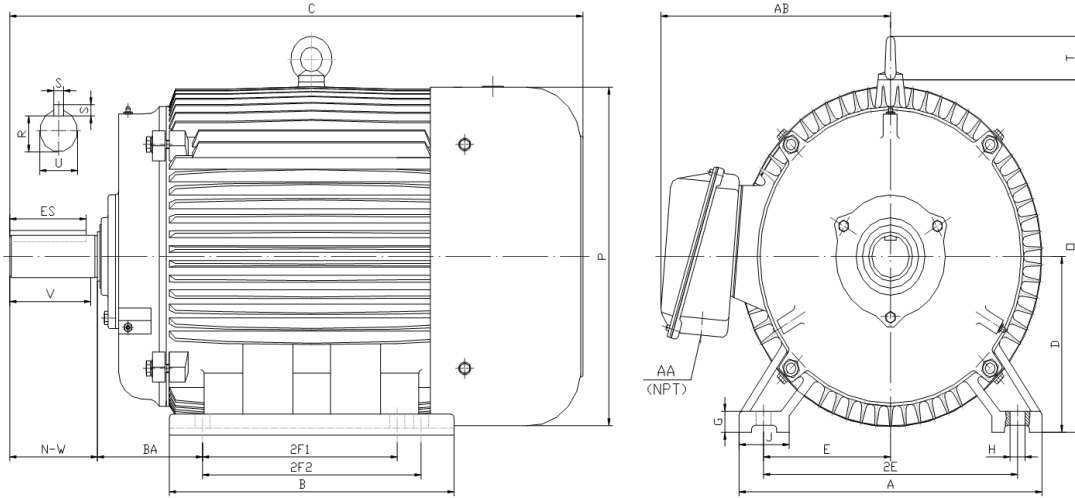

DIMENSIONS

HP	RPM	Frame	MOUNTING														
			A	B	C	D	G	H	J	E	2E	2F1	2F2	O	P	T	BA
300	3600	449TS	21.70	31.40	49.10	11.00	1.35	0.81	3.35	9.00	18.00	20.00	25.00	23.00	23.40	3.00	7.50

Shaft Extension, Key Set						Conduit Box		Bearings		Mount
U	V	R	S	ES	N-W	AA	AB	DE	ODE	
2.38	4.50	2.02	0.63	3.03	4.75	3.00	19.90	6314	6314	F1

BEARING LUBRICATION: The bearings come lubricated with Mobil Polyrex EM Polyurea Grease. It is recommended that you add some additional lubrication when the motor is installed.

Three options (brands) for suitable lubrication include, but are not limited to, the following:

- 1.) Mobil Polyrex EM
- 2.) Citco Polyurea MP
- 3.) Conoco Phillips Polytac EP





PE449TS-300-2-575V

GENERAL PURPOSE ELECTRIC MOTOR

NEMA PREMIUM EFFICIENCY

TOTALLY ENCLOSED FAN COOLED

INVERTER DUTY 10:1 CT; 20:1 VT - NEMA MG1 PART 31

Factory Certified for T2B Class I, Division II, Groups A,B,C & D and Class II, Division II, Groups F & G

PERFORMANCE DATA

HP	RPM	Frame	Voltage	Frequency (Hz)	Full Load S.F.	Insulation Class	NEMA Design	Slip (%)	NEMA Code	Enclosure Type	IP Rating	Max. Ambient
300	3580	449TS	575	60	1.15	F	B	0.6	G	TEFC	55	40° C

Amps (575V)		Efficiency (%)				Power Factor			Torque (ft-lb)			DE Bearing	ODE Bearing	Connection	Weight (lbs.)
FLA	LRA	100%	75%	50%	Min.	100%	75%	50%	FLT	LRT %	BDT %				
256.0	1760	95.8	95.5	95.1	95.0	0.910	0.910	0.890	440.9	130	245	6314	6314	6 Lead Δ	2002

NAME PLATE

									CONNECTION DIAGRAM 575 V Delta 			
INVERTER DUTY 20:1 VT; 10:1 CT												
CAT NO:		PE449TS-300-2-575V		HP	300	Hz	60	PHASE	3			
VOLTS		575		FLA	256.0		IP RATING		55			
RPM		3580		POWER FACTOR		0.91		DESIGN		B		
FRAME		449TS		NEMA NOM EFF		95.8		CODE		G		
DRIVE END BEARING		6314		NEMA MIN EFF		95.0		S.F.		1.15		
OPP DRIVE END BEARING		6314		MAX AMB		40° C		INS CLASS		F		
ENCL		TEFC		RATING	CONT		SER					
MOTOR WEIGHT		2002 LBS		CONNECTION		6 Lead Δ		LUB: Mobil Polyrex EM				
General purpose use on industrial machinery installed in damp, dusty or dirty environments. Hernando, Mississippi												CC 082A

APPLICATIONS:

General purpose use on pumps, fans, blowers, compressors, conveyors, material handling and other industrial machinery installed in damp, dusty or dirty environments.