

PE365TS-75-4

GENERAL PURPOSE ELECTRIC MOTOR

NEMA PREMIUM EFFICIENCY

TOTALLY ENCLOSED FAN COOLED

INVERTER DUTY 10:1 CT; 20:1 VT - NEMA MG1 PART 31

Factory Certified for T2B Class I, Division II, Groups A,B,C & D and Class II, Division II, Groups F & G

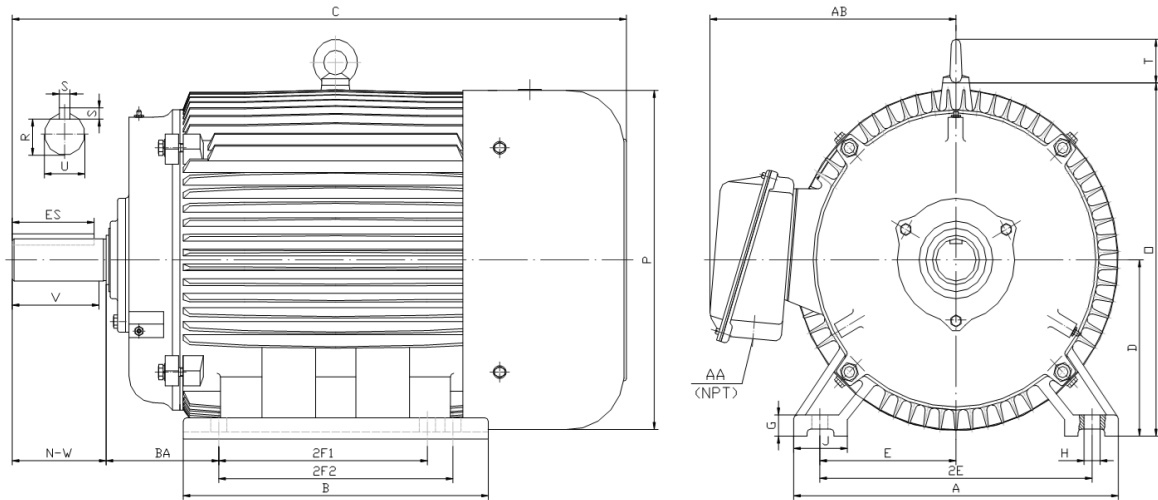

DIMENSIONS

HP	RPM	Frame	MOUNTING														
			A	B	C	D	G	H	J	E	2E	2F1	2F2	O	P	T	BA
75	1800	365TS	17.10	15.40	31.40	9.00	1.10	0.66	2.95	7.00	14.00	11.25	12.25	18.50	18.40	2.60	5.88

Shaft Extension, Key Set						Conduit Box		Bearings		Mount
U	V	R	S	ES	N-W	AA	AB	DE	ODE	
1.875	3.50	1.591	0.500	2.03	3.75	3.00	15.00	6313	6313	F1

BEARING LUBRICATION: The bearings come lubricated with Mobil Polyrex EM Polyurea Grease. It is recommended that you add some additional lubrication when the motor is installed.

Three options (brands) for suitable lubrication include, but are not limited to, the following:

- 1.) Mobil Polyrex EM
- 2.) Citco Polyurea MP
- 3.) Conoco Phillips Polytac EP





PE365TS-75-4

GENERAL PURPOSE ELECTRIC MOTOR

NEMA PREMIUM EFFICIENCY

TOTALLY ENCLOSED FAN COOLED

INVERTER DUTY 10:1 CT; 20:1 VT - NEMA MG1 PART 31







Factory Certified for T2B Class I, Division II, Groups A,B,C & D and Class II, Division II, Groups F & G

PERFORMANCE DATA

HP	RPM	Frame	Voltage	Frequency (Hz)	Full Load S.F.	Insulation Class	NEMA Design	Slip (%)	NEMA Code	Enclosure Type	IP Rating	Max. Ambient
75	1780	365TS	208-230-460	60	1.15	F	B	1.1	G	TEFC	55	40° C

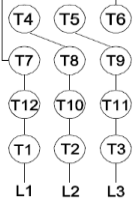
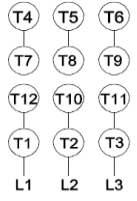
Amps (460V)		Efficiency (%)				Power Factor			Torque (ft-lb)			DE Bearing	ODE Bearing	Connection	Weight (lbs.)
FLA	LRA	100%	75%	50%	Min.	100%	75%	50%	FLT	LRT %	BDT %	6313	6313	12 Lead 2Δ/Δ	826
87.0	542	95.4	95.5	95.5	94.5	0.850	0.820	0.750	222.0	160	250				

NAME PLATE

 North American Electric, Inc.													CONNECTION DIAGRAMS 208-230V 		
INVERTER DUTY 20:1 VT; 10:1 CT															
CAT NO:		PE365TS-75-4			FRAME		365TS		PHASE		3				
HZ	60	S.F.	1.15	HZ	50	S.F.	1.0	ENCL	TEFC	IP	55				
HP	75	RPM	1780	HP	75	RPM	1480	DUTY	CONT	DES	B				
VOLTS		208-230-460			VOLTS		190/380		AMB	40° C	INS				F
FLA	193 - 174 / 87			FLA	210/105			DE BEARING		6313					
CODE	G	P.F.	0.85	CODE	F	P.F.	0.86	ODE BEARING		6313					
EFF	95.4	MIN	94.5	EFF	94	MIN	93.1	LUB:		Mobil Polyrex EM		460V 			
MOTOR WEIGHT	826	LBS	CONNECTION		12 Lead 2Δ/Δ		SER NO								
General purpose use on industrial machinery installed in damp, dusty or dirty environments. Hernando, Mississippi										  		CC 082A			

APPLICATIONS:

General purpose use on pumps, fans, blowers, compressors, conveyors, material handling and other industrial machinery installed in damp, dusty or dirty environments.