

PE365TS-75-2-575V

GENERAL PURPOSE ELECTRIC MOTOR

NEMA PREMIUM EFFICIENCY

TOTALLY ENCLOSED FAN COOLED

INVERTER DUTY 10:1 CT; 20:1 VT - NEMA MG1 PART 31

Factory Certified for T2B Class I, Division II, Groups A,B,C & D and Class II, Division II, Groups F & G

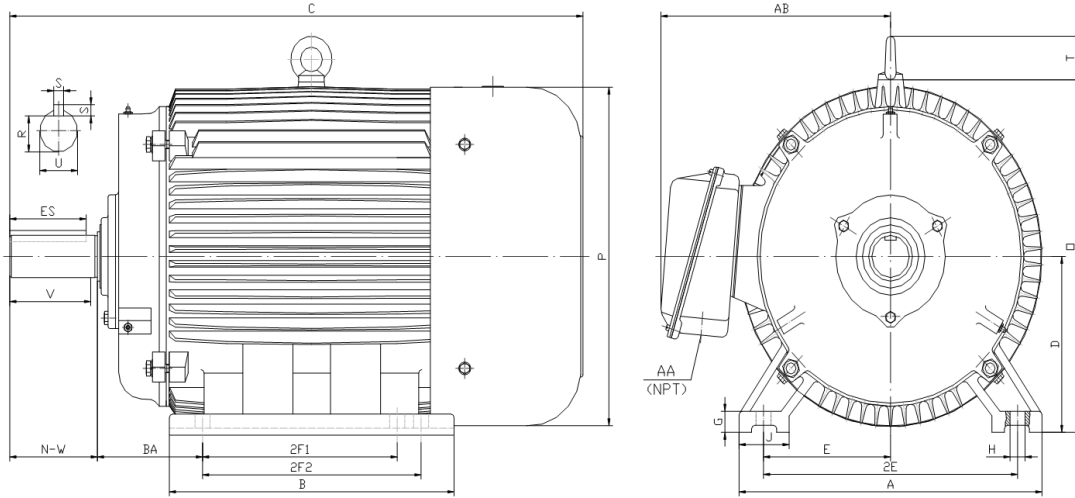

DIMENSIONS

HP	RPM	Frame	MOUNTING														
			A	B	C	D	G	H	J	E	2E	2F1	2F2	O	P	T	BA
75	3600	365TS	17.10	15.40	31.40	9.00	1.15	0.66	2.95	7.00	14.00	11.25	12.25	18.10	17.60	2.60	5.88

Shaft Extension, Key Set						Conduit Box		Bearings		Mount
U	V	R	S	ES	N-W	AA	AB	DE	ODE	
1.88	3.50	1.59	0.50	2.03	3.75	3.00	14.60	6313	6313	F1

BEARING LUBRICATION: The bearings come lubricated with Mobil Polyrex EM Polyurea Grease. It is recommended that you add some additional lubrication when the motor is installed.

Three options (brands) for suitable lubrication include, but are not limited to, the following:

- 1.) Mobil Polyrex EM
- 2.) Citco Polyurea MP
- 3.) Conoco Phillips Polytac EP





PE365TS-75-2-575V

GENERAL PURPOSE ELECTRIC MOTOR

NEMA PREMIUM EFFICIENCY

TOTALLY ENCLOSED FAN COOLED

INVERTER DUTY 10:1 CT; 20:1 VT - NEMA MG1 PART 31

Factory Certified for T2B Class I, Division II, Groups A,B,C & D and Class II, Division II, Groups F & G

PERFORMANCE DATA

HP	RPM	Frame	Voltage	Frequency (Hz)	Full Load S.F.	Insulation Class	NEMA Design	Slip (%)	NEMA Code	Enclosure Type	IP Rating	Max. Ambient
75	3565	365TS	575	60	1.15	F	B	1.0	G	TEFC	55	40° C

Amps (575V)		Efficiency (%)				Power Factor			Torque (ft-lb)			DE Bearing	ODE Bearing	Connection	Weight (lbs.)
FLA	LRA	100%	75%	50%	Min.	100%	75%	50%	FLT	LRT %	BDT %				
66.4	434	93.6	93.0	92.5	92.4	0.910	0.890	0.840	110.7	130	250	6313	6313	6 Lead Δ	766

NAME PLATE

									CONNECTION DIAGRAM 575 V Delta 			
INVERTER DUTY 20:1 VT; 10:1 CT												
CAT NO:	PE365TS-75-2-575V		HP	75	Hz	60	PHASE	3				
VOLTS	575		FLA	66.4		IP RATING	55					
RPM	3565		POWER FACTOR	0.91		DESIGN	B					
FRAME	365TS		NEMA NOM EFF	93.6		CODE	G					
DRIVE END BEARING	6313		NEMA MIN EFF	92.4		S.F.	1.15					
OPP DRIVE END BEARING	6313		MAX AMB	40° C		INS CLASS	F					
ENCL	TEFC		RATING	CONT		SER						
MOTOR WEIGHT	766	LBS	CONNECTION	6 Lead Δ		LUB:	Mobil Polyrex EM					
General purpose use on industrial machinery installed in damp, dusty or dirty environments. Hernando, Mississippi									CC 082A			

APPLICATIONS:

General purpose use on pumps, fans, blowers, compressors, conveyors, material handling and other industrial machinery installed in damp, dusty or dirty environments.