

## PE364T-60-4

GENERAL PURPOSE ELECTRIC MOTOR

NEMA PREMIUM EFFICIENCY

TOTALLY ENCLOSED FAN COOLED

INVERTER DUTY 10:1 CT; 20:1 VT - NEMA MG1 PART 31

Factory Certified for T2B Class I, Division II, Groups A,B,C & D and Class II, Division II, Groups F & G

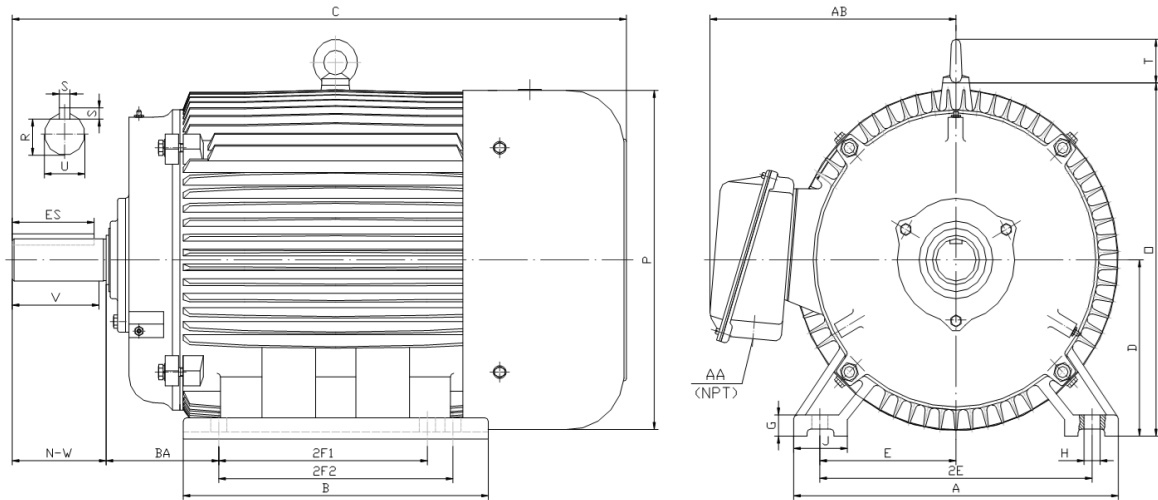

### DIMENSIONS

HP	RPM	Frame	MOUNTING														
			A	B	C	D	G	H	J	E	2E	2F1	2F2	O	P	T	BA
60	1800	364T	17.10	15.40	32.50	9.00	1.10	0.66	2.95	7.00	14.00	11.25	0.00	18.50	18.40	2.60	5.88

Shaft Extension, Key Set						Conduit Box		Bearings		Mount
U	V	R	S	ES	N-W	AA	AB	DE	ODE	
2.375	5.62	2.021	0.625	4.28	5.88	3.00	15.00	6313	6313	F1

**BEARING LUBRICATION:** The bearings come lubricated with Mobil Polyrex EM Polyurea Grease. It is recommended that you add some additional lubrication when the motor is installed.

Three options (brands) for suitable lubrication include, but are not limited to, the following:

- 1.) Mobil Polyrex EM
- 2.) Citco Polyurea MP
- 3.) Conoco Phillips Polytac EP





## PE364T-60-4

GENERAL PURPOSE ELECTRIC MOTOR

NEMA PREMIUM EFFICIENCY

TOTALLY ENCLOSED FAN COOLED

INVERTER DUTY 10:1 CT; 20:1 VT - NEMA MG1 PART 31







Factory Certified for T2B Class I, Division II, Groups A,B,C & D and Class II, Division II, Groups F & G

### PERFORMANCE DATA

HP	RPM	Frame	Voltage	Frequency (Hz)	Full Load S.F.	Insulation Class	NEMA Design	Slip (%)	NEMA Code	Enclosure Type	IP Rating	Max. Ambient
60	1780	364T	208-230/460	60	1.15	F	B	1.1	G	TEFC	55	40° C

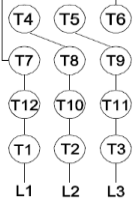
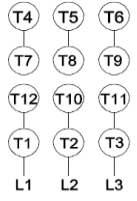
Amps (460V)		Efficiency (%)				Power Factor			Torque (ft-lb)			DE Bearing	ODE Bearing	Connection	Weight (lbs.)
FLA	LRA	100%	75%	50%	Min.	100%	75%	50%	FLT	LRT %	BDT %				
69.5	435	95.0	95.0	95.0	94.1	0.850	0.830	0.750	177.6	160	240	6313	6313	12 Lead 2Δ/Δ	801

### NAME PLATE

 <b>North American Electric, Inc.</b>													<b>CONNECTION DIAGRAMS</b> <b>208-230V</b> 		
<b>INVERTER DUTY 20:1 VT; 10:1 CT</b>															
CAT NO: PE364T-60-4			FRAME 364T			PHASE 3						<b>460V</b> 			
HZ 60	S.F. 1.15	HZ 50	S.F. 1.0	ENCL TEFC	IP 55										
HP 60	RPM 1780	HP 60	RPM 1480	DUTY CONT	DES B										
VOLTS 208-230/460			VOLTS 190/380			AMB 40° C			INS F						
FLA 154 - 139 / 69.5	FLA 168/84			DE BEARING 6313											
CODE G	P.F. 0.85	CODE F	P.F. 0.86	ODE BEARING 6313											
EFF 95.0	MIN 94.1	EFF 93.8	MIN 92.6	LUB: Mobil Polyrex EM											
MOTOR WEIGHT 801 LBS		CONNECTION 12 Lead 2Δ/Δ			SER NO										
General purpose use on industrial machinery installed in damp, dusty or dirty environments. Hernando, Mississippi										   CC 082A					

### APPLICATIONS:

General purpose use on pumps, fans, blowers, compressors, conveyors, material handling and other industrial machinery installed in damp, dusty or dirty environments.