

PE286T-30-4-575V

GENERAL PURPOSE ELECTRIC MOTOR

NEMA PREMIUM EFFICIENCY

TOTALLY ENCLOSED FAN COOLED

INVERTER DUTY 10:1 CT; 20:1 VT - NEMA MG1 PART 31

Factory Certified for T2B Class I, Division II, Groups A,B,C & D and Class II, Division II, Groups F & G

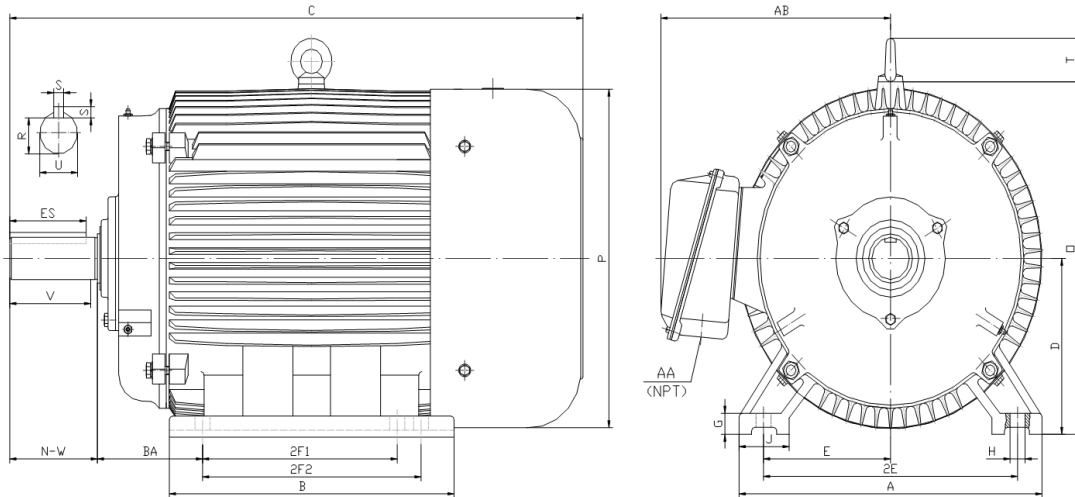

DIMENSIONS

HP	RPM	Frame	MOUNTING														
			A	B	C	D	G	H	J	E	2E	2F1	2F2	O	P	T	BA
30	1800	286T	14.00	13.20	28.10	7.00	0.85	0.53	2.75	5.50	11.00	9.50	11.00	14.50	14.00	2.20	4.75

Shaft Extension, Key Set						Conduit Box		Bearings		Mount
U	V	R	S	ES	N-W	AA	AB	DE	ODE	
1.88	4.38	1.59	0.50	3.28	4.62	1.50	11.30	6311	6311	F1

BEARING LUBRICATION: The bearings come lubricated with Mobil Polyrex EM Polyurea Grease. It is recommended that you add some additional lubrication when the motor is installed.

Three options (brands) for suitable lubrication include, but are not limited to, the following:

- 1.) Mobil Polyrex EM
- 2.) Citco Polyurea MP
- 3.) Conoco Phillips Polytac EP





PE286T-30-4-575V

GENERAL PURPOSE ELECTRIC MOTOR

NEMA PREMIUM EFFICIENCY

TOTALLY ENCLOSED FAN COOLED

INVERTER DUTY 10:1 CT; 20:1 VT - NEMA MG1 PART 31

Factory Certified for T2B Class I, Division II, Groups A,B,C & D and Class II, Division II, Groups F & G

PERFORMANCE DATA

HP	RPM	Frame	Voltage	Frequency (Hz)	Full Load S.F.	Insulation Class	NEMA Design	Slip (%)	NEMA Code	Enclosure Type	IP Rating	Max. Ambient
30	1775	286T	575	60	1.15	F	B	1.4	G	TEFC	55	40° C

Amps (575V)		Efficiency (%)				Power Factor			Torque (ft-lb)			DE Bearing	ODE Bearing	Connection	Weight (lbs.)
FLA	LRA	100%	75%	50%	Min.	100%	75%	50%	FLT	LRT %	BDT %				
28.2	174	93.6	93.6	93.0	92.4	0.840	0.810	0.710	89.1	160	250	6311	6311	6 Lead Δ	437

NAME PLATE

									CONNECTION DIAGRAM 575 V Delta 			
INVERTER DUTY 20:1 VT; 10:1 CT												
CAT NO:		PE286T-30-4-575V		HP	30	Hz	60	PHASE	3			
VOLTS		575		FLA	28.2		IP RATING	55				
RPM	1775		POWER FACTOR		0.84		DESIGN	B				
FRAME	286T		NEMA NOM EFF		93.6		CODE	G				
DRIVE END BEARING	6311		NEMA MIN EFF		92.4		S.F.	1.15				
OPP DRIVE END BEARING	6311		MAX AMB		40° C		INS CLASS	F				
ENCL	TEFC		RATING	CONT	SER							
MOTOR WEIGHT	437	LBS	CONNECTION	6 Lead Δ		LUB:	Mobil Polyrex EM					
General purpose use on industrial machinery installed in damp, dusty or dirty environments. Hernando, Mississippi												CC 082A

APPLICATIONS:

General purpose use on pumps, fans, blowers, compressors, conveyors, material handling and other industrial machinery installed in damp, dusty or dirty environments.