

**PE449T-200-6-575V**

**GENERAL PURPOSE ELECTRIC MOTOR**

**NEMA PREMIUM EFFICIENCY**

**TOTALLY ENCLOSED FAN COOLED**

**INVERTER DUTY 10:1 CT; 20:1 VT - NEMA MG1 PART 31**

Factory Certified for T2B Class I, Division II, Groups A,B,C & D and Class II, Division II, Groups F & G

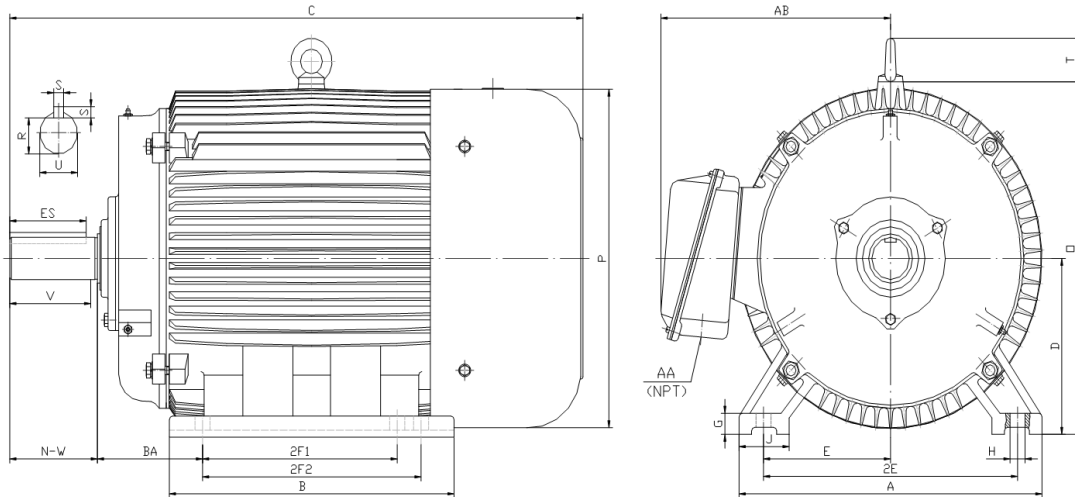

**DIMENSIONS**

HP	RPM	Frame	MOUNTING														
			A	B	C	D	G	H	J	E	2E	2F1	2F2	O	P	T	BA
200	1200	449T	21.70	31.40	52.80	11.00	1.35	0.81	3.35	9.00	18.00	20.00	25.00	23.00	23.40	3.00	7.50

Shaft Extension, Key Set						Conduit Box		Bearings		Mount
U	V	R	S	ES	N-W	AA	AB	DE	ODE	
3.38	8.25	2.88	0.88	6.91	8.50	3.00	19.90	NU319	6318	F1

**BEARING LUBRICATION:** The bearings come lubricated with Mobil Polyrex EM Polyurea Grease. It is recommended that you add some additional lubrication when the motor is installed.

Three options (brands) for suitable lubrication include, but are not limited to, the following:

- 1.) Mobil Polyrex EM
- 2.) Citco Polyurea MP
- 3.) Conoco Phillips Polytac EP





**PE449T-200-6-575V**

**GENERAL PURPOSE ELECTRIC MOTOR**

**NEMA PREMIUM EFFICIENCY**

**TOTALLY ENCLOSED FAN COOLED**

**INVERTER DUTY 10:1 CT; 20:1 VT - NEMA MG1 PART 31**

Factory Certified for T2B Class I, Division II, Groups A,B,C & D and Class II, Division II, Groups F & G

**PERFORMANCE DATA**

HP	RPM	Frame	Voltage	Frequency (Hz)	Full Load S.F.	Insulation Class	NEMA Design	Slip (%)	NEMA Code	Enclosure Type	IP Rating	Max. Ambient
200	1185	449T	575	60	1.15	F	B	1.3	G	TEFC	55	40° C

Amps (575V)		Efficiency (%)				Power Factor			Torque (ft-lb)			DE Bearing	ODE Bearing	Connection	Weight (lbs.)
FLA	LRA	100%	75%	50%	Min.	100%	75%	50%	FLT	LRT %	BDT %				
184.0	1160	95.8	95.6	95.0	95.0	0.830	0.790	0.710	885.0	140	245	NU319	6318	6 Lead Δ	2100

**NAME PLATE**

									<b>CONNECTION DIAGRAM</b>  <b>575 V Delta</b> 			
<b>INVERTER DUTY 20:1 VT; 10:1 CT</b>												
CAT NO:		PE449T-200-6-575V		HP	200	Hz	60	PHASE	3			
VOLTS		575		FLA	184.0		IP RATING		55			
RPM	1185		POWER FACTOR		0.83		DESIGN		B			
FRAME	449T		NEMA NOM EFF		95.8		CODE		G			
DRIVE END BEARING	NU319		NEMA MIN EFF		95.0		S.F.		1.15			
OPP DRIVE END BEARING	6318		MAX AMB		40° C		INS CLASS		F			
ENCL	TEFC		RATING	CONT		SER						
MOTOR WEIGHT	2100	LBS	CONNECTION	6 Lead Δ		LUB:		Mobil Polyrex EM				
General purpose use on industrial machinery installed in damp, dusty or dirty environments. Hernando, Mississippi												CC 082A

**APPLICATIONS:**

General purpose use on pumps, fans, blowers, compressors, conveyors, material handling and other industrial machinery installed in damp, dusty or dirty environments.