

PE445T-150-4-575V

GENERAL PURPOSE ELECTRIC MOTOR

NEMA PREMIUM EFFICIENCY

TOTALLY ENCLOSED FAN COOLED

INVERTER DUTY 10:1 CT; 20:1 VT - NEMA MG1 PART 31

Factory Certified for T2B Class I, Division II, Groups A,B,C & D and Class II, Division II, Groups F & G

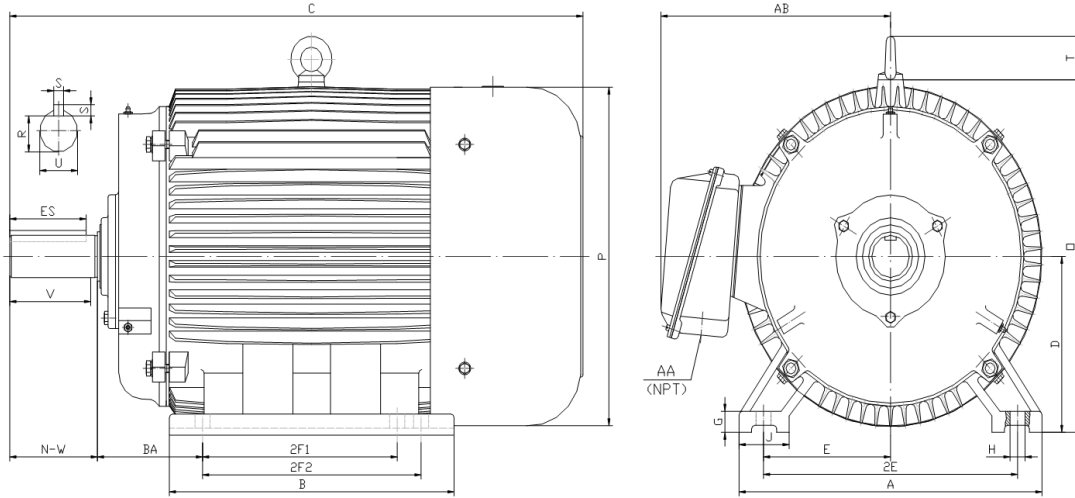

DIMENSIONS

HP	RPM	Frame	MOUNTING														
			A	B	C	D	G	H	J	E	2E	2F1	2F2	O	P	T	BA
150	1800	445T	21.70	22.90	44.30	11.00	1.35	0.81	3.35	9.00	18.00	14.50	16.50	23.00	23.40	3.00	7.50

Shaft Extension, Key Set						Conduit Box		Bearings		Mount
U	V	R	S	ES	N-W	AA	AB	DE	ODE	
3.38	8.25	2.88	0.88	6.91	8.50	3.00	19.90	NU319	6318	F1

BEARING LUBRICATION: The bearings come lubricated with Mobil Polyrex EM Polyurea Grease. It is recommended that you add some additional lubrication when the motor is installed.

Three options (brands) for suitable lubrication include, but are not limited to, the following:

- 1.) Mobil Polyrex EM
- 2.) Citco Polyurea MP
- 3.) Conoco Phillips Polytac EP





PE445T-150-4-575V

GENERAL PURPOSE ELECTRIC MOTOR

NEMA PREMIUM EFFICIENCY

TOTALLY ENCLOSED FAN COOLED

INVERTER DUTY 10:1 CT; 20:1 VT - NEMA MG1 PART 31

Factory Certified for T2B Class I, Division II, Groups A,B,C & D and Class II, Division II, Groups F & G

PERFORMANCE DATA

HP	RPM	Frame	Voltage	Frequency (Hz)	Full Load S.F.	Insulation Class	NEMA Design	Slip (%)	NEMA Code	Enclosure Type	IP Rating	Max. Ambient
150	1790	445T	575	60	1.15	F	B	0.6	G	TEFC	55	40° C

Amps (575V)		Efficiency (%)				Power Factor			Torque (ft-lb)			DE Bearing	ODE Bearing	Connection	Weight (lbs.)
FLA	LRA	100%	75%	50%	Min.	100%	75%	50%	FLT	LRT %	BDT %				
136.8	868	95.8	95.8	95.0	95.0	0.870	0.860	0.800	442.7	150	250	NU319	6318	6 Lead Δ	1672

NAME PLATE

										CONNECTION DIAGRAM 575 V Delta 				
INVERTER DUTY 20:1 VT; 10:1 CT														
CAT NO:		PE445T-150-4-575V			HP	150		Hz	60		PHASE	3		
VOLTS			575		FLA	136.8			IP RATING		55			
RPM		1790			POWER FACTOR			0.87		DESIGN			B	
FRAME		445T			NEMA NOM EFF			95.8		CODE			G	
DRIVE END BEARING		NU319			NEMA MIN EFF			95.0		S.F.			1.15	
OPP DRIVE END BEARING		6318			MAX AMB			40° C		INS CLASS			F	
ENCL		TEFC			RATING	CONT		SER						
MOTOR WEIGHT		1672 LBS		CONNECTION			6 Lead Δ		LUB:			Mobil Polyrex EM		
General purpose use on industrial machinery installed in damp, dusty or dirty environments. Hernando, Mississippi										CC 082A				

APPLICATIONS:

General purpose use on pumps, fans, blowers, compressors, conveyors, material handling and other industrial machinery installed in damp, dusty or dirty environments.