

PE405T-100-2

GENERAL PURPOSE ELECTRIC MOTOR

NEMA PREMIUM EFFICIENCY

TOTALLY ENCLOSED FAN COOLED

INVERTER DUTY 10:1 CT; 20:1 VT - NEMA MG1 PART 31

Factory Certified for T2B Class I, Division II, Groups A,B,C & D and Class II, Division II, Groups F & G

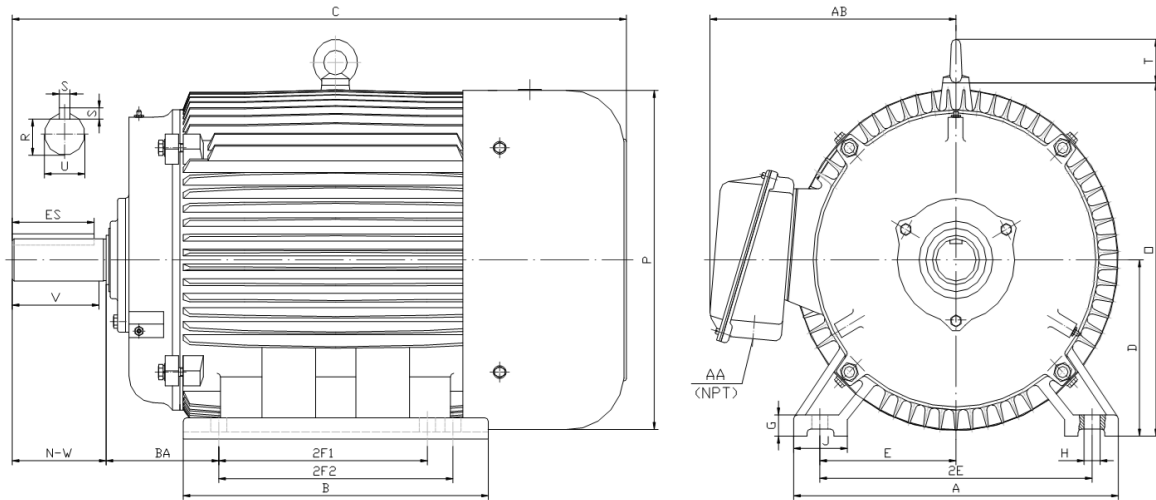

DIMENSIONS

HP	RPM	Frame	MOUNTING														
			A	B	C	D	G	H	J	E	2E	2F1	2F2	O	P	T	BA
100	3600	405T	19.30	17.90	38.00	10.00	1.18	0.81	3.15	8.00	16.00	12.25	13.75	19.80	19.10	2.60	6.62

Shaft Extension, Key Set						Conduit Box		Bearings		Mount
U	V	R	S	ES	N-W	AA	AB	DE	ODE	
2.875	7.00	2.450	0.750	5.65	7.25	3.00	15.60	6314	6314	F1

BEARING LUBRICATION: The bearings come lubricated with Mobil Polyrex EM Polyurea Grease. It is recommended that you add some additional lubrication when the motor is installed.

Three options (brands) for suitable lubrication include, but are not limited to, the following:

- 1.) Mobil Polyrex EM
- 2.) Citco Polyurea MP
- 3.) Conoco Phillips Polytac EP





PE405T-100-2

GENERAL PURPOSE ELECTRIC MOTOR

NEMA PREMIUM EFFICIENCY

TOTALLY ENCLOSED FAN COOLED

INVERTER DUTY 10:1 CT; 20:1 VT - NEMA MG1 PART 31







Factory Certified for T2B Class I, Division II, Groups A,B,C & D and Class II, Division II, Groups F & G

PERFORMANCE DATA

HP	RPM	Frame	Voltage	Frequency (Hz)	Full Load S.F.	Insulation Class	NEMA Design	Slip (%)	NEMA Code	Enclosure Type	IP Rating	Max. Ambient
100	3570	405T	208-230/460	60	1.15	F	B	0.8	G	TEFC	55	40° C

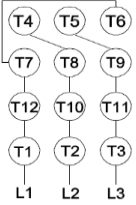
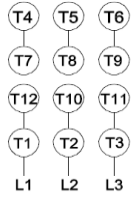
Amps (460V)		Efficiency (%)				Power Factor			Torque (ft-lb)			DE Bearing	ODE Bearing	Connection	Weight (lbs.)
FLA	LRA	100%	75%	50%	Min.	100%	75%	50%	FLT	LRT %	BDT %				
112.0	725	94.1	93.5	93.0	93.0	0.900	0.880	0.820	147.2	130	245	6314	6314	12 Lead 2Δ/Δ	1107

NAME PLATE

 North American Electric, Inc.													CONNECTION DIAGRAMS 208-230V 		
INVERTER DUTY 20:1 VT; 10:1 CT															
CAT NO: PE405T-100-2			FRAME 405T			PHASE 3						460V 			
HZ 60	S.F. 1.15	HZ 50	S.F. 1.0	ENCL TEFC	IP 55										
HP 100	RPM 3570	HP 100	RPM 2960	DUTY CONT	DES B										
VOLTS 208-230/460			VOLTS 190/380			AMB 40° C			INS F						
FLA 248 - 224 / 112	FLA 272/136			DE BEARING 6314											
CODE G	P.F. 0.90	CODE F	P.F. 0.91	ODE BEARING 6314											
EFF 94.1	MIN 93.0	EFF 92.6	MIN 91.5	LUB: Mobil Polyrex EM											
MOTOR WEIGHT 1107 LBS		CONNECTION 12 Lead 2Δ/Δ			SER NO										
General purpose use on industrial machinery installed in damp, dusty or dirty environments. Hernando, Mississippi										   CC 082A					

APPLICATIONS:

General purpose use on pumps, fans, blowers, compressors, conveyors, material handling and other industrial machinery installed in damp, dusty or dirty environments.