

PE213TC-3-6

GENERAL PURPOSE ELECTRIC MOTOR

NEMA PREMIUM EFFICIENCY

THREE PHASE, TOTALLY ENCLOSED FAN COOLED - C-FLANGE W/ FEET

INVERTER DUTY 10:1 CT; 20:1 VT - NEMA MG1 PART 31

Factory Certified for T2B Class I, Division II, Groups A,B,C & D and Class II, Division II, Groups F & G

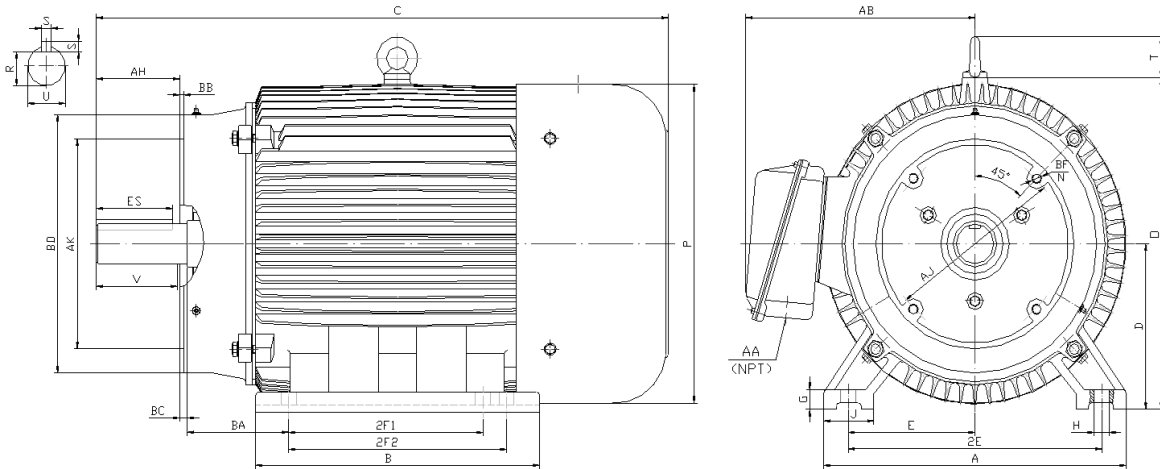

DIMENSIONS

| HP | RPM | Frame | MOUNTING | | | | | | | | | | | | | | |
|----|------|-------|----------|------|-------|------|------|------|------|------|------|------|------|-------|-------|------|------|
| | | | A | B | C | D | G | H | J | E | 2E | 2F1 | 2F2 | O | P | T | BA |
| 3 | 1200 | 213TC | 11.00 | 7.90 | 18.90 | 5.25 | 0.70 | 0.41 | 2.40 | 4.25 | 8.50 | 5.50 | 0.00 | 11.20 | 11.60 | 1.90 | 3.50 |

| FLANGE | | | | | | | Shaft Extension, Key Set | | | | | | Conduit Box | | Bearings | | Mount |
|--------|------|------|------|------|------|----------|--------------------------|------|------|------|------|-----|-------------|------|----------|---------|-------|
| AH | AJ | AK | BB | BC | BD | BF | U | V | R | S | ES | N-W | AA | AB | DE | ODE | |
| 3.12 | 7.25 | 8.50 | 0.25 | 0.25 | 9.00 | 4*1/2-13 | 1.38 | 3.12 | 1.20 | 0.31 | 2.41 | NA | 1.00 | 9.00 | 6308-ZZ | 6308-ZZ | F1 |

BEARING LUBRICATION: The bearings come lubricated with Mobil Polyrex EM Polyurea Grease.





PE213TC-3-6

GENERAL PURPOSE ELECTRIC MOTOR

NEMA PREMIUM EFFICIENCY

THREE PHASE, TOTALLY ENCLOSED FAN COOLED - C-FLANGE W/ FEET

INVERTER DUTY 10:1 CT; 20:1 VT - NEMA MG1 PART 31







Factory Certified for T2B Class I, Division II, Groups A,B,C & D and Class II, Division II, Groups F & G

PERFORMANCE DATA

| HP | RPM | Frame | Voltage | Frequency (Hz) | Full Load S.F. | Insulation Class | NEMA Design | Slip (%) | NEMA Code | Enclosure Type | IP Rating | Max. Ambient |
|----|------|-------|-------------|----------------|----------------|------------------|-------------|----------|-----------|----------------|-----------|--------------|
| 3 | 1185 | 213TC | 208-230/460 | 60 | 1.15 | F | B | 1.3 | K | TEFC | 55 | 40° C |

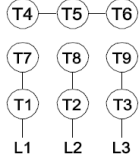
| Amps (460V) | | Efficiency (%) | | | | Power Factor | | | Torque (ft-lb) | | | DE Bearing | ODE Bearing | Connection | Weight (lbs.) |
|-------------|------|----------------|------|------|------|--------------|-------|-------|----------------|-------|-------|------------|-------------|-------------|---------------|
| FLA | LRA | 100% | 75% | 50% | Min. | 100% | 75% | 50% | FLT | LRT % | BDT % | | | | |
| 4.2 | 32.0 | 89.5 | 89.0 | 87.0 | 87.5 | 0.700 | 0.630 | 0.500 | 13.5 | 190 | 280 | 6308-ZZ | 6308-ZZ | 9 Lead 2Y/Y | 150 |

NAME PLATE

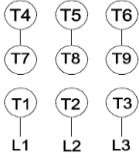
| | | | | | | | | | | | | | | | | | | | | | | | |
|--|--|-----------------|-----|-------------|--|-------|--|----------|------------|--|--|---|--|---|--|-----------------------|-----|-------|------|---------|------|---|----|
|  North American Electric, Inc. | | | | | | | | | |  | | | CONNECTION DIAGRAMS 208-230V  | | | | | | | | | | |
| INVERTER DUTY 20:1 VT; 10:1 CT | | | | | | | | | | | | | | | | | | | | | | | |
| CAT NO: | | PE213TC-3-6 | | | | FRAME | | 213TC | | PHASE | | 3 | | | | | | | | | | | |
| HZ | | 60 | | S.F. | | 1.15 | | HZ | | 50 | | S.F. | | | | | 1.0 | | ENCL | | TEFC | | IP |
| HP | | 3 | | RPM | | 1185 | | HP | | 3 | | RPM | | 980 | | DUTY | | CONT | | DES | | B | |
| VOLTS | | | | 208-230/460 | | | | VOLTS | | | | 190/380 | | | | AMB | | 40° C | | INS | | F | |
| FLA | | 9.2 - 8.4 / 4.2 | | | | FLA | | 10.4/5.2 | | | | DE BEARING | | | | 6308-ZZ | | | | | | | |
| CODE | | K | | P.F. | | 0.70 | | CODE | | H | | P.F. | | 0.75 | | ODE BEARING | | | | 6308-ZZ | | | |
| EFF | | 89.5 | | MIN | | 87.5 | | EFF | | 85.5 | | MIN | | 83.5 | | LUB: Mobil Polyrex EM | | | | | | | |
| MOTOR WEIGHT | | | 150 | | | LBS | | | CONNECTION | | | 9 Lead 2Y/Y | | | SER NO | | | | | | | | |
| General purpose use on industrial machinery installed in damp, dusty or dirty environments. Hernando, Mississippi | | | | | | | | | |  | |  | |  | | CC 082A | | | | | | | |
| | | | | | | | | | | | | | | | 460V  | | | | | | | | |

APPLICATIONS:

General purpose use on pumps, fans, blowers, compressors, conveyors, material handling and other industrial machinery installed in damp, dusty or dirty environments.