

PEXP445T-150-4

EXPLOSION PROOF ELECTRIC MOTOR

NEMA PREMIUM EFFICIENCY

TOTALLY ENCLOSED FAN COOLED; EXPLOSION PROOF ENCLOSURE

CLASS I DIVISION I GROUP C & D; CLASS II DIVISION I GROUP F & G

OPERATING TEMP CODE T3C

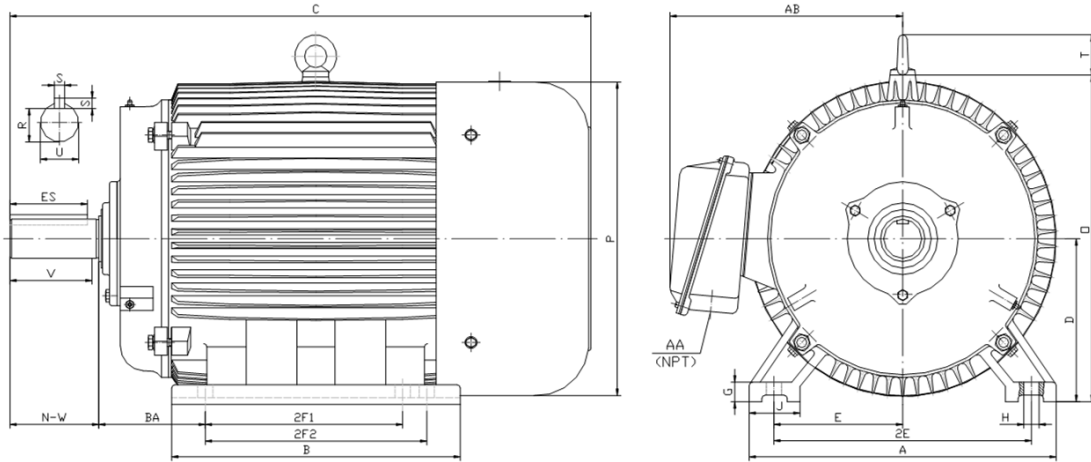

DIMENSIONS

HP	RPM	Frame	MOUNTING														
			A	B	C	D	G	H	J	E	2E	2F1	2F2	O	P	T	BA
150	1800	445T	21.70	22.90	44.30	11.00	1.35	0.81	3.35	9.00	18.00	14.50	16.50	23.00	23.40	3.00	7.50

Shaft Extension, Key Set						Conduit Box		Bearings		Mount
U	V	R	S	ES	N-W	AA	AB	DE	ODE	
3.38	8.25	2.88	0.88	6.91	8.50	3.00	19.90	6318	6314	F1

BEARING LUBRICATION: The bearings come lubricated with Mobil Polyrex EM Polyurea Grease. It is recommended that you add some additional lubrication when the motor is installed.

Three options (brands) for suitable lubrication include, but are not limited to, the following:

- 1.) Mobil Polyrex EM
- 2.) Citco Polyurea MP
- 3.) Conoco Phillips Polytac EP









PEXP445T-150-4
EXPLOSION PROOF ELECTRIC MOTOR
NEMA PREMIUM EFFICIENCY
TOTALLY ENCLOSED FAN COOLED; EXPLOSION PROOF ENCLOSURE
CLASS I DIVISION I GROUP C & D; CLASS II DIVISION I GROUP F & G
OPERATING TEMP CODE T3C
PERFORMANCE DATA

HP	RPM	Frame	Voltage	Frequency (Hz)	Full Load S.F.	Insulation Class	NEMA Design	Slip (%)	NEMA Code	Enclosure Type	IP Rating	Max. Ambient	Oper Temp Code	Max. KVAR
150	1789	445T	460	60	1.15	F	B	0.6	G	TEXP	55	40° C	T3C	33.9

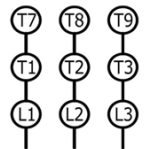
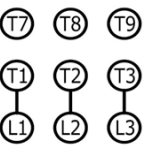
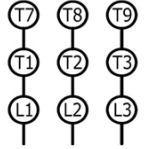
Amps (460V)		Max. Amps (208V)	Efficiency (%)				Power Factor			Torque (ft-lb)			DE Bearing	ODE Bearing	Connection	Weight (lbs.)
FLA	LRA	60HZ	100%	75%	50%	Min.	100%	75%	50%	FLT	LRT %	BDT %				
162.5	1085	359.4	95.8	95.8	95.7	95.0	0.86	0.86	0.82	440.0	110	200	6318	6314	6 Lead Δ	1898

NAME PLATE

 North American Electric, Inc.												CONNECTION DIAGRAMS ACROSS THE LINE 							
PREMIUM EFFICIENT EXPLOSION PROOF MOTOR																			
CAT NO: PEXP445T-150-4			FRAME 445T			PHASE 3			PWS START 										
DE BRG 6318		ODE BRG 6314		CONN. 6 Lead Δ															
MAX AMB. 40° C		INS. CLASS F		RATING CONT		WEIGHT 1898													
USABLE ON 208V 60HZ AT 359.4						MAX AMPS SER													
DIVISION 1 CLASS I GROUP C D CLASS II GROUP F G						OPER TEMP CODE T3C													
60 HERTZ DATA						HP 150		RPM 1789		HP 150		RPM 1491		50 HERTZ DATA PWS RUN 					
						VOLTS 460				VOLTS 380									
						F.L. AMPS 163				F.L. AMPS 197									
						S.F. AMPS 186.9				S.F. AMPS 197									
						S.F. 1.15 DESIGN B CODE G				S.F. 1.0 DESIGN B CODE H									
						NEMA NOM.EFF. 95.8 % P.F. 0.86				NEMA NOM.EFF. 95.5 % P.F. 0.86									
						NEMA MIN.EFF. 95.0 %				NEMA MIN.EFF. 94.6 %									
MAX. KVAR 33.9				LUB. Mobil Polyrex EM															
<small>General purpose use on industrial machinery installed in damp, dusty or dirty environments. These motors are designed for use in hazardous locations defined by class and group.</small>												   CC 041B							
Hernando, Mississippi																			

	ELECTRIC MOTORS FOR HAZARDOUS LOCATIONS
	CLASS I DIVISION I GROUP C D, CLASS II DIVISION I GROUP F G
	NO. CCXXXXX E310089

APPLICATIONS:

General purpose use on pumps, fans, blowers, compressors, conveyors, material handling and other industrial machinery installed in damp, dusty or dirty environments. These motors are designed to be used in hazardous locations as defined by class and group.