

PEXP404T-60-6

EXPLOSION PROOF ELECTRIC MOTOR

NEMA PREMIUM EFFICIENCY

TOTALLY ENCLOSED FAN COOLED; EXPLOSION PROOF ENCLOSURE

CLASS I DIVISION I GROUP C & D; CLASS II DIVISION I GROUP F & G

OPERATING TEMP CODE T3C

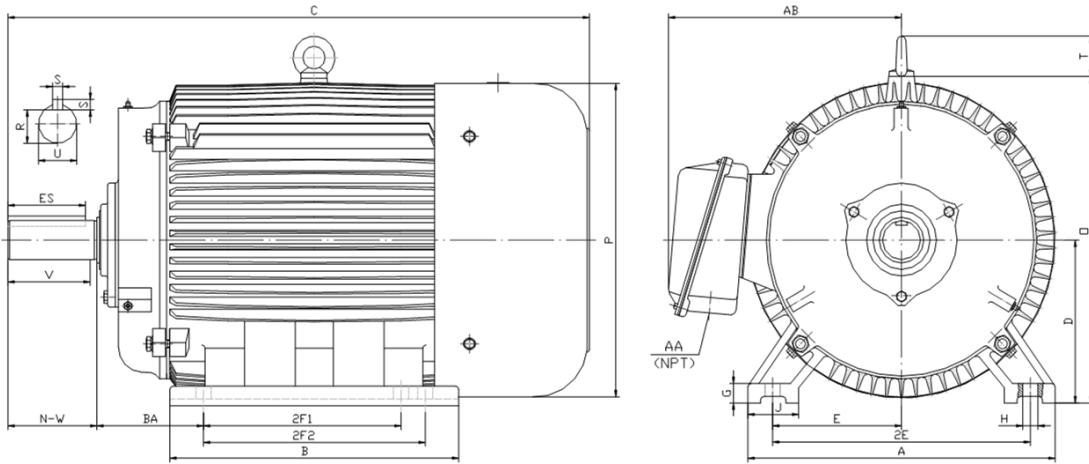

DIMENSIONS

HP	RPM	Frame	MOUNTING														
			A	B	C	D	G	H	J	E	2E	2F1	2F2	O	P	T	BA
60	1200	404T	19.30	17.90	38.00	10.00	1.25	0.81	3.15	8.00	16.00	12.25	13.75	21.10	21.60	2.60	6.62

Shaft Extension, Key Set						Conduit Box		Bearings		Mount
U	V	R	S	ES	N-W	AA	AB	DE	ODE	
2.88	7.00	2.45	0.75	5.65	7.25	3.00	16.60	6316	6314	F1

BEARING LUBRICATION: The bearings come lubricated with Mobil Polyrex EM Polyurea Grease. It is recommended that you add some additional lubrication when the motor is installed.

Three options (brands) for suitable lubrication include, but are not limited to, the following:

- 1.) Mobil Polyrex EM
- 2.) Citco Polyurea MP
- 3.) Conoco Phillips Polytac EP









PEXP404T-60-6
EXPLOSION PROOF ELECTRIC MOTOR
NEMA PREMIUM EFFICIENCY
TOTALLY ENCLOSED FAN COOLED; EXPLOSION PROOF ENCLOSURE
CLASS I DIVISION I GROUP C & D; CLASS II DIVISION I GROUP F & G
OPERATING TEMP CODE T3C
PERFORMANCE DATA

HP	RPM	Frame	Voltage	Frequency (Hz)	Full Load S.F.	Insulation Class	NEMA Design	Slip (%)	NEMA Code	Enclosure Type	IP Rating	Max. Ambient	Oper Temp Code	Max. KVAR
60	1192	404T	208-230/460	60	1.15	F	B	0.7	G	TEXP	55	40° C	T3C	17.8

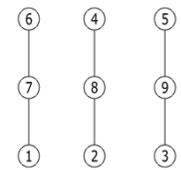
Amps (460V)		Max. Amps (208V)	Efficiency (%)				Power Factor			Torque (ft-lb)			DE Bearing	ODE Bearing	Connection	Weight (lbs.)
FLA	LRA	60HZ	100%	75%	50%	Min.	100%	75%	50%	FLT	LRT %	BDT %				
69.0	435.0	152.6	94.5	94.5	94.1	93.6	0.83	0.86	0.79	264.0	135	200	6316	6314	9 Lead 2Δ/Δ	1188

NAME PLATE

 North American Electric, Inc.				PREMIUM EFFICIENT EXPLOSION PROOF MOTOR		CONNECTION DIAGRAMS		
CAT NO: PEXP404T-60-6		FRAME: 404T						PHASE: 3
DE BRG: 6316		ODE BRG: 6314		CONN.: 9 Lead 2Δ/Δ		208V-230V		
MAX AMB.: 40° C		INS. CLASS: F		RATING CONT:		WEIGHT: 1188		
USABLE ON 208V 60HZ AT: 152.6		MAX AMPS:		SER:				
DIVISION 1 CLASS I GROUP C D CLASS II GROUP F G				OPER TEMP CODE: T3C				
60 HERTZ DATA	HP: 60		RPM: 1192		HP: 60		RPM: 993	
	VOLTS: 208-230/460				VOLTS: 190/380			
	F.L. AMPS: 152.6 - 138 / 69				F.L. AMPS: 167/83.5			
	S.F. AMPS: 79.4				S.F. AMPS: 167/83.5			
	S.F.: 1.15 DESIGN B CODE G				S.F.: 1.0 DESIGN B CODE H			
	NEMA NOM.EFF.: 94.5 % P.F. 0.83				NEMA NOM.EFF.: 93.7 % P.F. 0.83			
	NEMA MIN.EFF.: 93.6 %				NEMA MIN.EFF.: 92.4 %			
MAX. KVAR: 17.8		LUB.: Mobil Polyrex EM						
<small>General purpose use on industrial machinery installed in damp, dusty or dirty environments. These motors are designed for use in hazardous locations defined by class and group.</small>								
Hernando, Mississippi								
		CC 041B						

	ELECTRIC MOTORS FOR HAZARDOUS LOCATIONS
	CLASS I DIVISION I GROUP C D, CLASS II DIVISION I GROUP F G NO. CCXXXXX E310089

APPLICATIONS:

General purpose use on pumps, fans, blowers, compressors, conveyors, material handling and other industrial machinery installed in damp, dusty or dirty environments. These motors are designed to be used in hazardous locations as defined by class and group.