

**PEXP364T-60-4**

**EXPLOSION PROOF ELECTRIC MOTOR**

**NEMA PREMIUM EFFICIENCY**

**TOTALLY ENCLOSED FAN COOLED; EXPLOSION PROOF ENCLOSURE**

**CLASS I DIVISION I GROUP C & D; CLASS II DIVISION I GROUP F & G**

**OPERATING TEMP CODE T3C**

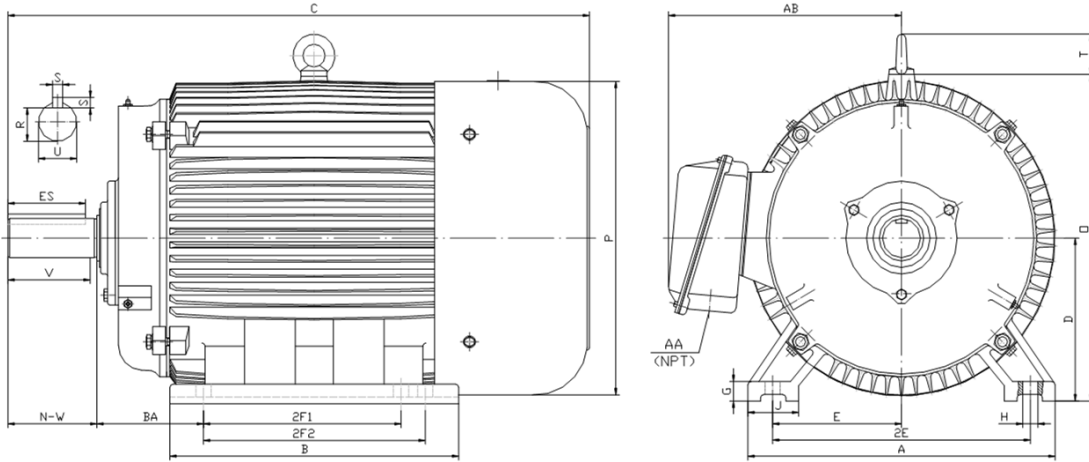

**DIMENSIONS**

HP	RPM	Frame	MOUNTING														
			A	B	C	D	G	H	J	E	2E	2F1	2F2	O	P	T	BA
60	1800	364T	17.10	15.40	32.50	9.00	1.10	0.66	2.95	7.00	14.00	11.25	0.00	18.50	18.40	2.60	5.88

Shaft Extension, Key Set						Conduit Box		Bearings		Mount
U	V	R	S	ES	N-W	AA	AB	DE	ODE	
2.38	5.62	2.02	0.63	4.28	5.88	3.00	15.00	6314	6314	F1

**BEARING LUBRICATION:** The bearings come lubricated with Mobil Polyrex EM Polyurea Grease. It is recommended that you add some additional lubrication when the motor is installed.

Three options (brands) for suitable lubrication include, but are not limited to, the following:

- 1.) Mobil Polyrex EM
- 2.) Citco Polyurea MP
- 3.) Conoco Phillips Polytac EP









**PEXP364T-60-4**
**EXPLOSION PROOF ELECTRIC MOTOR**
**NEMA PREMIUM EFFICIENCY**
**TOTALLY ENCLOSED FAN COOLED; EXPLOSION PROOF ENCLOSURE**
**CLASS I DIVISION I GROUP C & D; CLASS II DIVISION I GROUP F & G**
**OPERATING TEMP CODE T3C**
**PERFORMANCE DATA**

HP	RPM	Frame	Voltage	Frequency (Hz)	Full Load S.F.	Insulation Class	NEMA Design	Slip (%)	NEMA Code	Enclosure Type	IP Rating	Max. Ambient	Oper Temp Code	Max. KVAR
60	1786	364T	208-230/460	60	1.15	F	B	0.8	G	TEXP	55	40° C	T3C	17.4

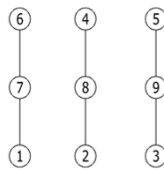
Amps (460V)		Max. Amps (208V)	Efficiency (%)				Power Factor			Torque (ft-lb)			DE Bearing	ODE Bearing	Connection	Weight (lbs.)
FLA	LRA	60HZ	100%	75%	50%	Min.	100%	75%	50%	FLT	LRT %	BDT %				
66.5	435.0	147.1	95.0	94.9	94.2	94.1	0.85	0.83	0.78	176.0	140	200	6314	6314	9 Lead 2Δ/Δ	891

**NAME PLATE**

 <b>North American Electric, Inc.</b>															<b>CONNECTION DIAGRAMS</b>  <b>208V-230V</b> 				
<b>PREMIUM EFFICIENT EXPLOSION PROOF MOTOR</b>																			
CAT NO: PEXP364T-60-4			FRAME 364T			PHASE 3													
DE BRG 6314		ODE BRG 6314		CONN. 9 Lead 2Δ/Δ															
MAX AMB. 40° C		INS. CLASS F		RATING CONT		WEIGHT 891													
USABLE ON 208V 60HZ AT 147.1 MAX AMPS				SER															
DIVISION 1 CLASS I GROUP C D CLASS II GROUP F G						OPER TEMP CODE T3C													
60 HERTZ DATA	HP 60		RPM 1786		HP 60		RPM 1488		50 HERTZ DATA										
	VOLTS 208-230/460				VOLTS 190/380														
	F.L. AMPS 147.1 - 133 / 66.5				F.L. AMPS 161/80.5														
	S.F. AMPS 76.5				S.F. AMPS 161/80.5														
	S.F. 1.15 DESIGN B CODE G				S.F. 1.0 DESIGN B CODE H														
	NEMA NOM.EFF. 95.0 % P.F. 0.85				NEMA NOM.EFF. 94.2 % P.F. 0.85														
	NEMA MIN.EFF. 94.1 %				NEMA MIN.EFF. 93.0 %														
MAX. KVAR 17.4		LUB. Mobil Polyrex EM																	
<small>General purpose use on industrial machinery installed in damp, dusty or dirty environments. These motors are designed for use in hazardous locations defined by class and group.</small>										   <b>CC 041B</b>									
Hernando, Mississippi																			

	<b>ELECTRIC MOTORS FOR HAZARDOUS LOCATIONS</b>
	<small>CLASS I DIVISION I GROUP C D, CLASS II DIVISION I GROUP F G NO. CCXXXXX E310089</small>

**APPLICATIONS:**

General purpose use on pumps, fans, blowers, compressors, conveyors, material handling and other industrial machinery installed in damp, dusty or dirty environments. These motors are designed to be used in hazardous locations as defined by class and group.