

PEXP286TS-30-2

EXPLOSION PROOF ELECTRIC MOTOR

NEMA PREMIUM EFFICIENCY

TOTALLY ENCLOSED FAN COOLED; EXPLOSION PROOF ENCLOSURE

CLASS I DIVISION I GROUP C & D; CLASS II DIVISION I GROUP F & G

OPERATING TEMP CODE T3C

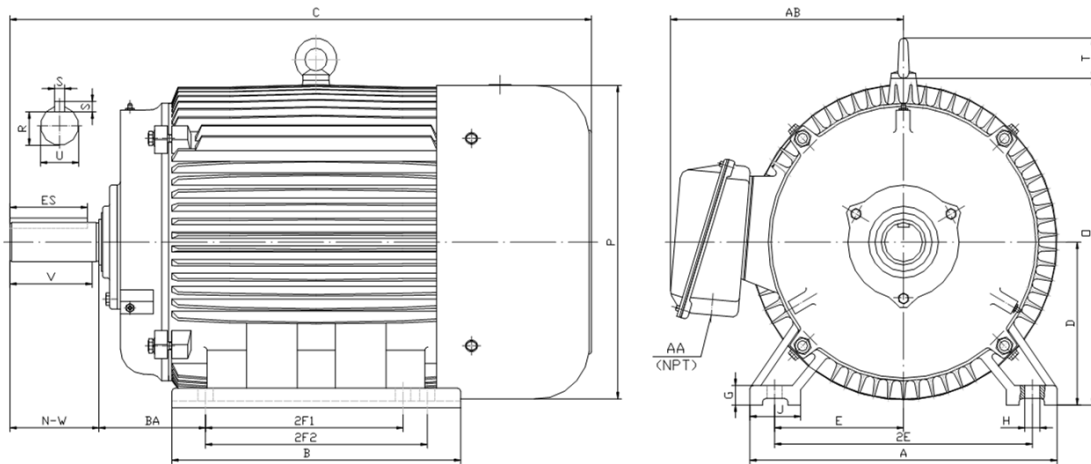

DIMENSIONS

HP	RPM	Frame	MOUNTING														
			A	B	C	D	G	H	J	E	2E	2F1	2F2	O	P	T	BA
30	3600	286TS	14.00	13.20	26.70	7.00	0.85	0.53	2.75	5.50	11.00	9.50	11.00	14.50	14.00	2.20	4.75

Shaft Extension, Key Set						Conduit Box		Bearings		Mount
U	V	R	S	ES	N-W	AA	AB	DE	ODE	
1.63	3.00	1.42	0.38	1.91	3.25	1.50	11.30	6310	6310	F1

BEARING LUBRICATION: The bearings come lubricated with Mobil Polyrex EM Polyurea Grease. It is recommended that you add some additional lubrication when the motor is installed.

Three options (brands) for suitable lubrication include, but are not limited to, the following:

- 1.) Mobil Polyrex EM
- 2.) Citco Polyurea MP
- 3.) Conoco Phillips Polytac EP









PEXP286TS-30-2
EXPLOSION PROOF ELECTRIC MOTOR
NEMA PREMIUM EFFICIENCY
TOTALLY ENCLOSED FAN COOLED; EXPLOSION PROOF ENCLOSURE
CLASS I DIVISION I GROUP C & D; CLASS II DIVISION I GROUP F & G
OPERATING TEMP CODE T3C
PERFORMANCE DATA

HP	RPM	Frame	Voltage	Frequency (Hz)	Full Load S.F.	Insulation Class	NEMA Design	Slip (%)	NEMA Code	Enclosure Type	IP Rating	Max. Ambient	Oper Temp Code	Max. KVAR
30	3560	286TS	208-230/460	60	1.15	F	B	1.1	G	TEXP	55	40° C	T3C	6.9

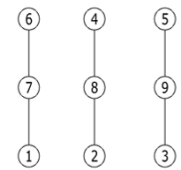
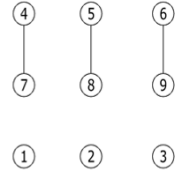
Amps (460V)		Max. Amps (208V)	Efficiency (%)				Power Factor			Torque (ft-lb)			DE Bearing	ODE Bearing	Connection	Weight (lbs.)
FLA	LRA	60HZ	100%	75%	50%	Min.	100%	75%	50%	FLT	LRT %	BDT %				
32.5	217.5	71.9	91.7	91.9	91.5	90.2	0.89	0.82	0.78	53.3	130	200	6310	6310	9 Lead 2Δ/Δ	528

NAME PLATE

 North American Electric, Inc.															CONNECTION DIAGRAMS 208V-230V 		
PREMIUM EFFICIENT EXPLOSION PROOF MOTOR																	
CAT NO: PEXP286TS-30-2			FRAME 286TS			PHASE 3											
DE BRG 6310			ODE BRG 6310			CONN. 9 Lead 2Δ/Δ											
MAX AMB. 40° C			INS. CLASS F			RATING CONT		WEIGHT 528									
USABLE ON 208V 60HZ AT 71.9 MAX AMPS						SER											
DIVISION 1 CLASS I GROUP C D CLASS II GROUP F G						OPER TEMP CODE T3C											
60 HERTZ DATA	HP 30		RPM 3560		HP 30		RPM 2967		50 HERTZ DATA			460V 					
	VOLTS 208-230/460				VOLTS 190/380												
	F.L. AMPS 71.9 - 65 / 32.5				F.L. AMPS 78.7/39.4												
	S.F. AMPS 37.4				S.F. AMPS 78.7/39.4												
	S.F. 1.15 DESIGN B CODE G				S.F. 1.0 DESIGN B CODE H												
	NEMA NOM.EFF. 91.7 % P.F. 0.89				NEMA NOM.EFF. 92.8 % P.F. 0.89												
	NEMA MIN.EFF. 90.2 %				NEMA MIN.EFF. 91.4 %												
MAX. KVAR 6.9		LUB. Mobil Polyrex EM															
<small>General purpose use on industrial machinery installed in damp, dusty or dirty environments. These motors are designed for use in hazardous locations defined by class and group.</small>										   CC 041B							
Hernando, Mississippi																	

ELECTRIC MOTORS FOR HAZARDOUS LOCATIONS
 CLASS I DIVISION I GROUP C D, CLASS II DIVISION I GROUP F G
 NO. CCXXXXX E310089

APPLICATIONS:

General purpose use on pumps, fans, blowers, compressors, conveyors, material handling and other industrial machinery installed in damp, dusty or dirty environments. These motors are designed to be used in hazardous locations as defined by class and group.