

**PE449TC-250-4**

GENERAL PURPOSE ELECTRIC MOTOR

NEMA PREMIUM EFFICIENCY

THREE PHASE, TOTALLY ENCLOSED FAN COOLED - C-FLANGE W/ FEET

INVERTER DUTY 10:1 CT; 20:1 VT - NEMA MG1 PART 31

Factory Certified for T2B Class I, Division II, Groups A,B,C & D and Class II, Division II, Groups F & G

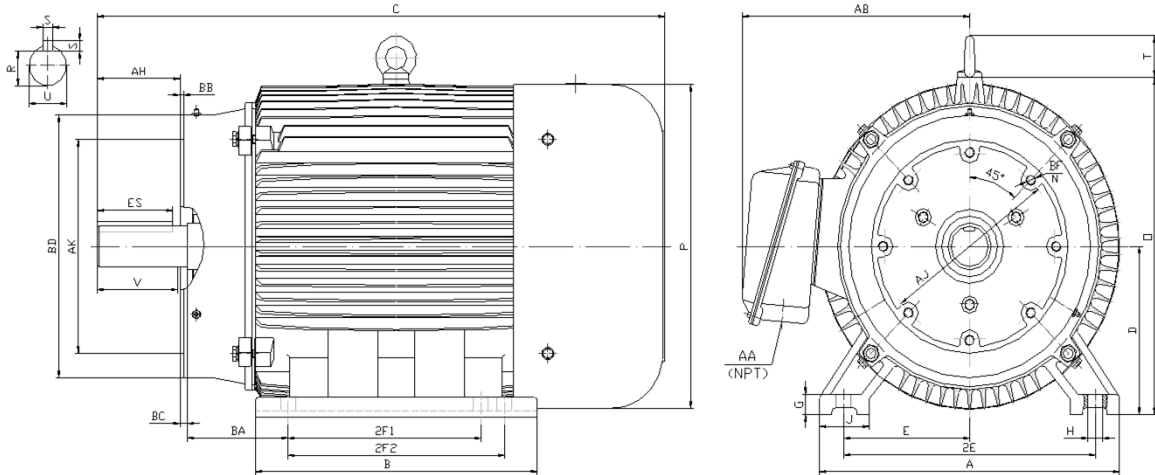

**DIMENSIONS**

HP	RPM	Frame	MOUNTING														
			A	B	C	D	G	H	J	E	2E	2F1	2F2	O	P	T	BA
250	1800	449TC	21.70	31.40	52.80	11.00	1.35	0.81	3.35	9.00	18.00	20.00	25.00	23.00	23.40	3.00	7.50

FLANGE							Shaft Extension, Key Set						Conduit Box		Bearings		Mount
AH	AJ	AK	BB	BC	BD	BF	U	V	R	S	ES	N-W	AA	AB	DE	ODE	
8.25	14.00	16.00	0.25	0.25	18.00	8*5/8-11	3.38	8.25	2.88	0.88	6.91	8.50	3.00	19.90	6319	6318	F1

**BEARING LUBRICATION:** The bearings come lubricated with Mobil Polyrex EM Polyurea Grease. It is recommended that you add some additional lubrication when the motor is installed.

Three options (brands) for suitable lubrication include, but are not limited to, the following:

- 1.) Mobil Polyrex EM
- 2.) Citco Polyurea MP
- 3.) Conoco Phillips Polytac EP





**PE449TC-250-4**

**GENERAL PURPOSE ELECTRIC MOTOR**

**NEMA PREMIUM EFFICIENCY**

**THREE PHASE, TOTALLY ENCLOSED FAN COOLED - C-FLANGE W/ FEET**

**INVERTER DUTY 10:1 CT; 20:1 VT - NEMA MG1 PART 31**







Factory Certified for T2B Class I, Division II, Groups A,B,C & D and Class II, Division II, Groups F & G

**PERFORMANCE DATA**

HP	RPM	Frame	Voltage	Frequency (Hz)	Full Load S.F.	Insulation Class	NEMA Design	Slip (%)	NEMA Code	Enclosure Type	IP Rating	Max. Ambient
250	1790	449TC	460	60	1.15	F	B	0.6	G	TEFC	55	40° C

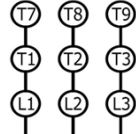
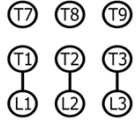
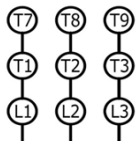
Amps (460V)		Efficiency (%)				Power Factor			Torque (ft-lb)			DE Bearing	ODE Bearing	Connection	Weight (lbs.)
FLA	LRA	100%	75%	50%	Min.	100%	75%	50%	FLT	LRT %	BDT %				
280.0	1825	96.2	96.0	95.3	95.4	0.870	0.860	0.800	737.8	140	250	6319	6318	6 Lead Δ	2150

**NAME PLATE**

 <b>North American Electric, Inc.</b>													<b>CONNECTION DIAGRAMS (460V)</b>										
<b>INVERTER DUTY 20:1 VT; 10:1 CT</b>										<b>ACROSS THE LINE</b>													
										<b>PWS START</b>													
										<b>PWS RUN</b>													
																							
CAT NO:		PE449TC-250-4				FRAME		449TC		PHASE		3											
HZ		60		S.F.		1.15		HZ		50		S.F.		1.0		ENCL		TEFC		IP		55	
HP		250		RPM		1790		HP		250		RPM		1488		DUTY		CONT		DES B			
VOLTS				460				VOLTS				380				AMB		40° C		INS F			
FLA				280.0				FLA				342				DE BEARING				6319			
CODE		G		P.F.		0.87		CODE		D		P.F.		0.87		ODE BEARING				6318			
EFF		96.2		MIN		95.4		EFF		95		MIN		94.1		LUB: Mobil Polyrex EM							
MOTOR WEIGHT		2150		LBS		CONNECTION				6 Lead Δ				SER NO									
General purpose use on industrial machinery installed in damp, dusty or dirty environments. Hernando, Mississippi																CC 082A							

**APPLICATIONS:**

General purpose use on pumps, fans, blowers, compressors, conveyors, material handling and other industrial machinery installed in damp, dusty or dirty environments.