

PE326TC-50-4

GENERAL PURPOSE ELECTRIC MOTOR

NEMA PREMIUM EFFICIENCY

THREE PHASE, TOTALLY ENCLOSED FAN COOLED - C-FLANGE W/ FEET

INVERTER DUTY 10:1 CT; 20:1 VT - NEMA MG1 PART 31

Factory Certified for T2B Class I, Division II, Groups A,B,C & D and Class II, Division II, Groups F & G

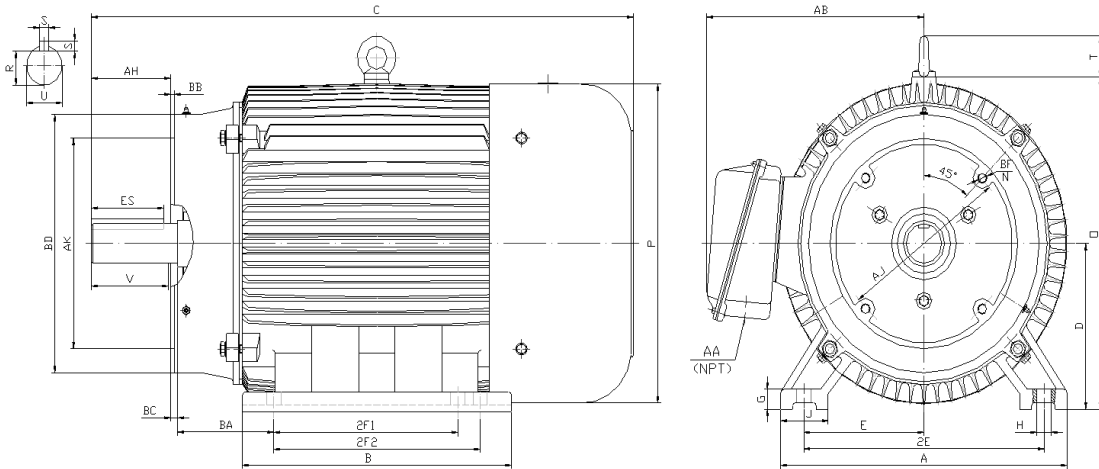

DIMENSIONS

HP	RPM	Frame	MOUNTING														
			A	B	C	D	G	H	J	E	2E	2F1	2F2	O	P	T	BA
50	1800	326TC	15.50	14.70	31.30	8.00	1.00	0.66	2.75	6.25	12.50	10.50	12.00	15.90	15.70	2.60	5.25

FLANGE							Shaft Extension, Key Set						Conduit Box		Bearings		Mount
AH	AJ	AK	BB	BC	BD	BF	U	V	R	S	ES	N-W	AA	AB	DE	ODE	
5.00	11.00	12.50	0.25	0.25	14.00	4*5/8-11	2.13	5.00	1.85	0.50	3.91	NA	2.00	12.30	6312	6312	F1

BEARING LUBRICATION: The bearings come lubricated with Mobil Polyrex EM Polyurea Grease. It is recommended that you add some additional lubrication when the motor is installed.

Three options (brands) for suitable lubrication include, but are not limited to, the following:

- 1.) Mobil Polyrex EM
- 2.) Citco Polyurea MP
- 3.) Conoco Phillips Polytac EP





PE326TC-50-4

GENERAL PURPOSE ELECTRIC MOTOR

NEMA PREMIUM EFFICIENCY

THREE PHASE, TOTALLY ENCLOSED FAN COOLED - C-FLANGE W/ FEET

INVERTER DUTY 10:1 CT; 20:1 VT - NEMA MG1 PART 31







Factory Certified for T2B Class I, Division II, Groups A,B,C & D and Class II, Division II, Groups F & G

PERFORMANCE DATA

HP	RPM	Frame	Voltage	Frequency (Hz)	Full Load S.F.	Insulation Class	NEMA Design	Slip (%)	NEMA Code	Enclosure Type	IP Rating	Max. Ambient
50	1780	326TC	208-230/460	60	1.15	F	B	1.1	G	TEFC	55	40° C

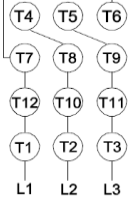
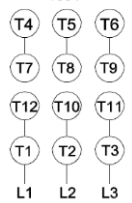
Amps (460V)		Efficiency (%)				Power Factor			Torque (ft-lb)			DE Bearing	ODE Bearing	Connection	Weight (lbs.)
FLA	LRA	100%	75%	50%	Min.	100%	75%	50%	FLT	LRT %	BDT %				
58.3	362.0	94.5	94.5	94.6	93.6	0.830	0.790	0.700	148.4	160	255	6312	6312	12 Lead 2Δ/Δ	626

NAME PLATE

 North American Electric, Inc.															CONNECTION DIAGRAMS 208-230V 		
INVERTER DUTY 20:1 VT; 10:1 CT																	
CAT NO: PE326TC-50-4				FRAME 326TC				PHASE 3				460V 					
HZ 60	S.F. 1.15	HZ 50	S.F. 1.0	ENCL TEFC	IP 55												
HP 50	RPM 1780	HP 50	RPM 1475	DUTY CONT	DES B												
VOLTS 208-230/460			VOLTS 190/380			AMB 40° C		INS F									
FLA 124 - 116.6 / 58.3			FLA 143/71.5			DE BEARING 6312											
CODE G	P.F. 0.83	CODE F	P.F. 0.85	ODE BEARING 6312													
EFF 94.5	MIN 93.6	EFF 93	MIN 91.8	LUB: Mobil Polyrex EM													
MOTOR WEIGHT 626 LBS		CONNECTION 12 Lead 2Δ/Δ			SER NO												
General purpose use on industrial machinery installed in damp, dusty or dirty environments. Hernando, Mississippi																CC 082A	

APPLICATIONS:

General purpose use on pumps, fans, blowers, compressors, conveyors, material handling and other industrial machinery installed in damp, dusty or dirty environments.