

PEXP182T-1.5-6

EXPLOSION PROOF ELECTRIC MOTOR

NEMA PREMIUM EFFICIENCY

TOTALLY ENCLOSED FAN COOLED; EXPLOSION PROOF ENCLOSURE

CLASS I DIVISION I GROUP C & D; CLASS II DIVISION I GROUP F & G

OPERATING TEMP CODE T3C

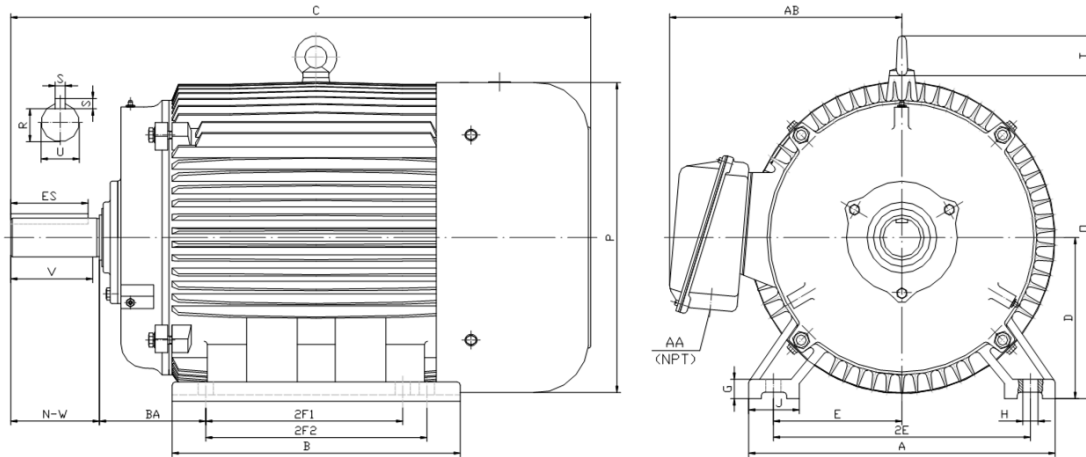

DIMENSIONS

HP	RPM	Frame	MOUNTING														
			A	B	C	D	G	H	J	E	2E	2F1	2F2	O	P	T	BA
1.5	1200	182T	9.50	7.30	16.10	4.50	0.60	0.41	2.00	3.75	7.50	4.50	5.50	9.10	8.70	1.60	2.75

Shaft Extension, Key Set						Conduit Box		Bearings		Mount
U	V	R	S	ES	N-W	AA	AB	DE	ODE	
1.125	2.50	0.986	0.250	1.78	2.75	0.75	7.50	6306-ZZ	6306-ZZ	F1

BEARING LUBRICATION: The bearings come lubricated with Mobil Polyrex EM Polyurea Grease.









PEXP182T-1.5-6
EXPLOSION PROOF ELECTRIC MOTOR
NEMA PREMIUM EFFICIENCY
TOTALLY ENCLOSED FAN COOLED; EXPLOSION PROOF ENCLOSURE
CLASS I DIVISION I GROUP C & D; CLASS II DIVISION I GROUP F & G
OPERATING TEMP CODE T3C
PERFORMANCE DATA

HP	RPM	Frame	Voltage	Frequency (Hz)	Full Load S.F.	Insulation Class	NEMA Design	Slip (%)	NEMA Code	Enclosure Type	IP Rating	Max. Ambient	Oper Temp Code	Max. KVAR
1.5	1183	182T	208-230/460	60	1.15	F	B	1.4	M	TEXP	55	40° C	T3C	1.2

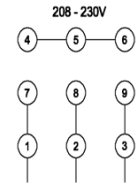
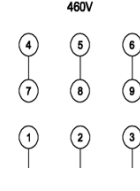
Amps (460V)		Max. Amps (208V)	Efficiency (%)				Power Factor			Torque (ft-lb)			DE Bearing	ODE Bearing	Connection	Weight (lbs.)
FLA	LRA	60HZ	100%	75%	50%	Min.	100%	75%	50%	FLT	LRT %	BDT %				
2.1	20.0	4.6	87.5	87.0	84.5	85.5	0.71	0.65	0.52	6.7	165	250	6306-ZZ	6306-ZZ	9 Lead 2Y/Y	115

NAME PLATE

 North American Electric, Inc.				PREMIUM EFFICIENT EXPLOSION PROOF MOTOR		CONNECTION DIAGRAMS	
CAT NO: PEXP182T-1.5-6		FRAME 182T		PHASE 3			
DE BRG 6306-ZZ		ODE BRG 6306-ZZ		CONN. 9 Lead 2Y/Y			
MAX AMB. 40° C		INS. CLASS F		RATING CONT WEIGHT 115			
USABLE ON 208V 60HZ AT 4.6		MAX AMPS		SER			
DIVISION 1 CLASS I GROUP C D CLASS II GROUP F G				OPER TEMP CODE T3C			
HP 1.5		RPM 1183		HP 1.5			
VOLTS 208-230/460		VOLTS 190/380		F.L. AMPS 5/2.5		F.L. AMPS 5/2.5	
S.F. AMPS 2.4		S.F. AMPS 5/2.5		NEMA NOM.EFF. 81.1 % P.F. 0.71		NEMA NOM.EFF. 87.5 % P.F. 0.71	
S.F. 1.15 DESIGN B CODE M		S.F. 1.0 DESIGN B CODE N		NEMA MIN.EFF. 77.3 %		NEMA MIN.EFF. 85.5 %	
MAX. KVAR 1.2		LUB. Mobil Polyrex EM		<small>General purpose use on industrial machinery installed in damp, dusty or dirty environments. These motors are designed for use in hazardous locations defined by class and group.</small>			
						CC 041B	
Hernando, Mississippi							

	ELECTRIC MOTORS FOR HAZARDOUS LOCATIONS CLASS I DIVISION I GROUP C D, CLASS II DIVISION I GROUP F G NO. CCXXXXX E310089
---	--

APPLICATIONS:

General purpose use on pumps, fans, blowers, compressors, conveyors, material handling and other industrial machinery installed in damp, dusty or dirty environments. These motors are designed to be used in hazardous locations as defined by class and group.