

**PEXP324TC-40-4**

**EXPLOSION PROOF ELECTRIC MOTOR**

**NEMA PREMIUM EFFICIENCY**

**TOTALLY ENCLOSED FAN COOLED; EXPLOSION PROOF ENCLOSURE**

**CLASS I DIVISION I GROUP C & D; CLASS II DIVISION I GROUP F & G**

**OPERATING TEMP CODE T3C**

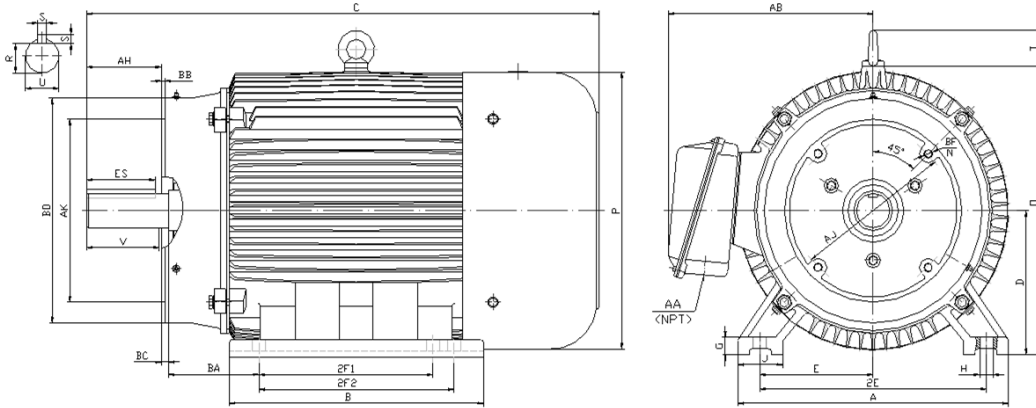

**DIMENSIONS**

HP	RPM	Frame	MOUNTING														
			A	B	C	D	G	H	J	E	2E	2F1	2F2	O	P	T	BA
40	1800	324TC	15.50	14.70	29.80	8.00	1.00	0.66	2.75	6.25	12.50	10.50	0.00	15.90	15.70	2.60	5.25

FLANGE							Shaft Extension, Key Set						Conduit Box		Bearings		Mount
AH	AJ	AK	BB	BC	BD	BF	U	V	R	S	ES	N-W	AA	AB	DE	ODE	
5.00	11.00	12.50	0.25	0.25	14.00	4*5/8-11	2.13	5.00	1.85	0.50	3.91	5.25	2.00	12.30	6312	6312	F1

**BEARING LUBRICATION:** The bearings come lubricated with Mobil Polyrex EM Polyurea Grease. It is recommended that you add some additional lubrication when the motor is installed.

Three options (brands) for suitable lubrication include, but are not limited to, the following:

- 1.) Mobil Polyrex EM
- 2.) Citco Polyurea MP
- 3.) Conoco Phillips Polytac EP



## PEXP324TC-40-4

**EXPLOSION PROOF ELECTRIC MOTOR**

**NEMA PREMIUM EFFICIENCY**

**TOTALLY ENCLOSED FAN COOLED; EXPLOSION PROOF ENCLOSURE**

**CLASS I DIVISION I GROUP C & D; CLASS II DIVISION I GROUP F & G**







**OPERATING TEMP CODE T3C**

### PERFORMANCE DATA

HP	RPM	Frame	Voltage	Frequency (Hz)	Full Load S.F.	Insulation Class	NEMA Design	Slip (%)	NEMA Code	Enclosure Type	IP Rating	Max. Ambient	Oper Temp Code	Max. KVAR
40	1783	324TC	208-230/460	60	1.15	F	B	0.9	G	TEXP	55	40° C	40° C	11.2

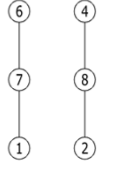
Amps (460V)		Max. Amps (208V)	Efficiency (%)				Power Factor			Torque (ft-lb)			DE Bearing	ODE Bearing	Connection	Weight (lbs.)
FLA	LRA	60HZ	100%	75%	50%	Min.	100%	75%	50%	FLT	LRT %	BDT %	6312	6312	9 Lead 2Δ/Δ	734
44.5	290	98.41	94.1	94.2	93.9	93	0.850	0.841	0.778	117.8	140	200				

### NAME PLATE

 										CONNECTION DIAGRAMS										
<b>PREMIUM EFFICIENT EXPLOSION PROOF MOTOR</b>																				
CAT NO:		PEXP324TC-40-4		FRAME		324TC		PHASE		3		208V-230V								
DE BRG		6312		ODE BRG		6312		CONN.		9 Lead 2Δ/Δ										
MAX AMB.		40° C		INS. CLASS		F		RATING		CONT		WEIGHT		734						
USABLE ON 208V 60HZ AT				98.4		MAX AMPS		SER												
DIVISION 1 CLASS I GROUP C D CLASS II GROUP F G						OPER TEMP CODE									40° C					
60 HERTZ DATA		HP		40		RPM		1783		HP		40		RPM		1486		50 HERTZ DATA		
		VOLTS				208-230/460				VOLTS				190/380						
		F.L. AMPS				44.5				F.L. AMPS				107.7/53.9						
		S.F. AMPS				51.2				S.F. AMPS				107.7/53.9						
		S.F. 1.15 DESIGN B CODE G								S.F. 1.0 DESIGN B CODE H										
		NEMA NOM.EFF. 94.1 % P.F. 0.85								NEMA NOM.EFF. 94.1 % P.F. 0.85										
		NEMA MIN.EFF. 93.0 %								NEMA MIN.EFF. 92.2 %										
MAX. KVAR				11.2				LUB.				Mobil Polyrex EM								
<small>General purpose use on industrial machinery installed in damp, dusty or dirty environments. These motors are designed for use in hazardous locations defined by class and group.</small>										  										
<small>Hernando, Mississippi</small>													CC 041B							

	<b>ELECTRIC MOTORS FOR HAZARDOUS LOCATIONS</b> CLASS I DIVISION I GROUP C D, CLASS II DIVISION I GROUP F G NO. CCXXXXX E310089
---	--

### APPLICATIONS:

General purpose use on pumps, fans, blowers, compressors, conveyors, material handling and other industrial machinery installed in damp, dusty or dirty environments. These motors are designed to be used in hazardous locations as defined by class and group.