

PEXP286TC-30-4

EXPLOSION PROOF ELECTRIC MOTOR

NEMA PREMIUM EFFICIENCY

TOTALLY ENCLOSED FAN COOLED; EXPLOSION PROOF ENCLOSURE

CLASS I DIVISION I GROUP C & D; CLASS II DIVISION I GROUP F & G

OPERATING TEMP CODE T3C

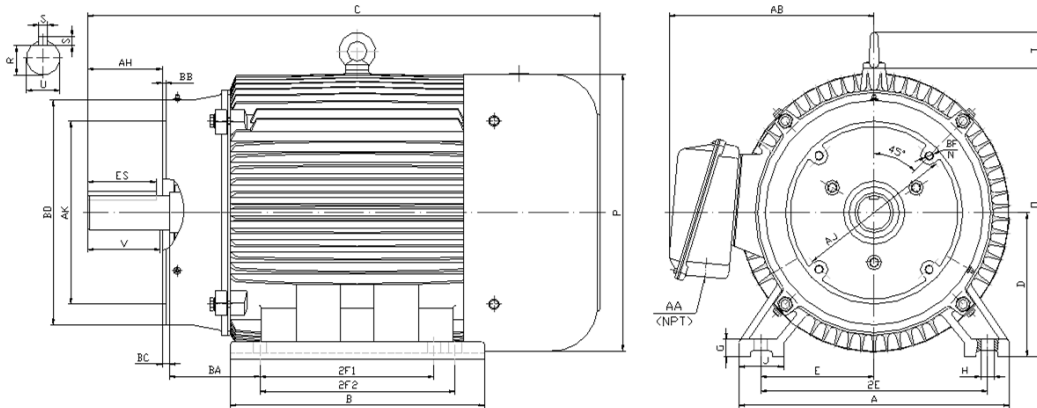

DIMENSIONS

HP	RPM	Frame	MOUNTING														
			A	B	C	D	G	H	J	E	2E	2F1	2F2	O	P	T	BA
30	1800	286TC	14.00	13.20	28.10	7.00	0.85	0.53	2.75	5.50	11.00	9.50	11.00	14.50	14.00	2.20	4.75

FLANGE							Shaft Extension, Key Set						Conduit Box		Bearings		Mount
AH	AJ	AK	BB	BC	BD	BF	U	V	R	S	ES	N-W	AA	AB	DE	ODE	
4.38	9.00	10.50	0.25	0.25	11.25	4*1/2-13	1.88	4.38	1.59	0.50	3.28	4.62	1.50	11.30	6311	6311	F1

BEARING LUBRICATION: The bearings come lubricated with Mobil Polyrex EM Polyurea Grease. It is recommended that you add some additional lubrication when the motor is installed.

Three options (brands) for suitable lubrication include, but are not limited to, the following:

- 1.) Mobil Polyrex EM
- 2.) Citco Polyurea MP
- 3.) Conoco Phillips Polytac EP



PEXP286TC-30-4

EXPLOSION PROOF ELECTRIC MOTOR

NEMA PREMIUM EFFICIENCY

TOTALLY ENCLOSED FAN COOLED; EXPLOSION PROOF ENCLOSURE

CLASS I DIVISION I GROUP C & D; CLASS II DIVISION I GROUP F & G







OPERATING TEMP CODE T3C

PERFORMANCE DATA

HP	RPM	Frame	Voltage	Frequency (Hz)	Full Load S.F.	Insulation Class	NEMA Design	Slip (%)	NEMA Code	Enclosure Type	IP Rating	Max. Ambient	Oper Temp Code	Max. KVAR
30	1777	286TC	208-230/460	60	1.15	F	B	1.3	G	TEXP	55	40° C	40° C	7.6

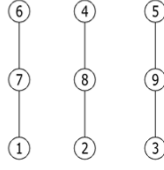
Amps (460V)		Max. Amps (208V)	Efficiency (%)				Power Factor			Torque (ft-lb)			DE Bearing	ODE Bearing	Connection	Weight (lbs.)
FLA	LRA	60HZ	100%	75%	50%	Min.	100%	75%	50%	FLT	LRT %	BDT %	6310	6310	9 Lead 2Δ/Δ	580
32.5	217.5	71.88	93.6	93.7	93.1	92.4	0.870	0.862	0.805	88.7	150	200				

NAME PLATE

 										CONNECTION DIAGRAMS						
PREMIUM EFFICIENT EXPLOSION PROOF MOTOR																
CAT NO:		PEXP286TC-30-4		FRAME		286TC		PHASE		3		208V-230V 				
DE BRG		6310		ODE BRG		6310		CONN.		9 Lead 2Δ/Δ						
MAX AMB.		40° C		INS. CLASS		F		RATING		CONT		WEIGHT		580		
USABLE ON 208V 60HZ AT				71.9		MAX AMPS		SER								
DIVISION 1 CLASS I GROUP C D CLASS II GROUP F G						OPER TEMP CODE						40° C				
60 HERTZ DATA	HP		30		RPM		1777		HP		30		RPM		1481	
	VOLTS				208-230/460				VOLTS				190/380			
	F.L. AMPS				32.5				F.L. AMPS				78.7/39.4			
	S.F. AMPS				37.4				S.F. AMPS				78.7/39.4			
	S.F. 1.15 DESIGN				B CODE G				S.F. 1.0 DESIGN				B CODE H			
	NEMA NOM.EFF.				93.6 % P.F. 0.87				NEMA NOM.EFF.				93.6 % P.F. 0.87			
	NEMA MIN.EFF.				92.4 %				NEMA MIN.EFF.				91.6 %			
	MAX. KVAR				7.6				LUB.				Mobil Polyrex EM			
<small>General purpose use on industrial machinery installed in damp, dusty or dirty environments. These motors are designed for use in hazardous locations defined by class and group.</small>										  						
<small>Hernando, Mississippi</small>													CC 041B			

	ELECTRIC MOTORS FOR HAZARDOUS LOCATIONS CLASS I DIVISION I GROUP C D, CLASS II DIVISION I GROUP F G NO. CCXXXXX E310089
---	--

APPLICATIONS:

General purpose use on pumps, fans, blowers, compressors, conveyors, material handling and other industrial machinery installed in damp, dusty or dirty environments. These motors are designed to be used in hazardous locations as defined by class and group.