

## PEXP254TC-15-2

EXPLOSION PROOF ELECTRIC MOTOR

NEMA PREMIUM EFFICIENCY

TOTALLY ENCLOSED FAN COOLED; EXPLOSION PROOF ENCLOSURE

CLASS I DIVISION I GROUP C & D; CLASS II DIVISION I GROUP F & G

OPERATING TEMP CODE T3C

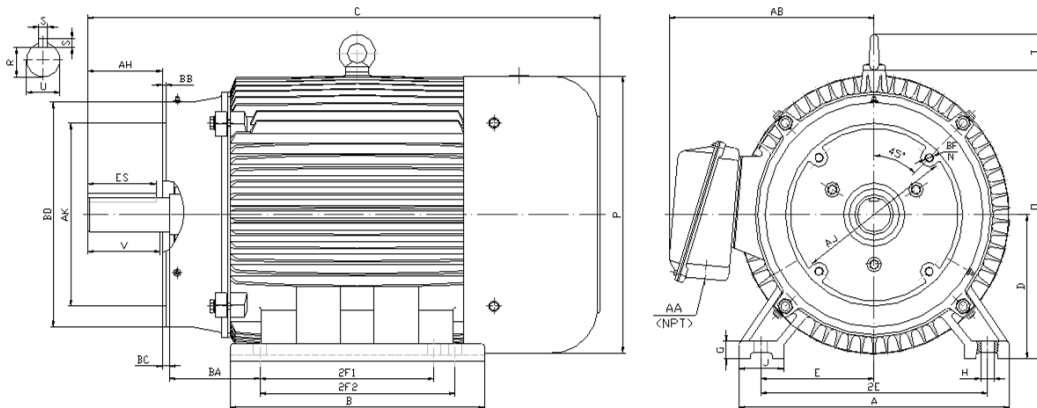

### DIMENSIONS

HP	RPM	Frame	MOUNTING														
			A	B	C	D	G	H	J	E	2E	2F1	2F2	O	P	T	BA
15	3600	254TC	13.00	12.20	23.20	6.25	0.70	0.53	2.75	5.00	10.00	8.25	0.00	13.20	12.80	2.20	4.25

FLANGE							Shaft Extension, Key Set						Conduit Box		Bearings		Mount
AH	AJ	AK	BB	BC	BD	BF	U	V	R	S	ES	N-W	AA	AB	DE	ODE	
3.75	7.25	8.50	0.25	0.25	10.00	4*1/2-13	1.63	3.75	1.42	0.38	2.91	4.00	1.25	10.30	6309	6309	F1

**BEARING LUBRICATION:** The bearings come lubricated with Mobil Polyrex EM Polyurea Grease. It is recommended that you add some additional lubrication when the motor is installed.

Three options (brands) for suitable lubrication include, but are not limited to, the following:

- 1.) Mobil Polyrex EM
- 2.) Citco Polyurea MP
- 3.) Conoco Phillips Polytac EP









**PEXP254TC-15-2**
**EXPLOSION PROOF ELECTRIC MOTOR**
**NEMA PREMIUM EFFICIENCY**
**TOTALLY ENCLOSED FAN COOLED; EXPLOSION PROOF ENCLOSURE**
**CLASS I DIVISION I GROUP C & D; CLASS II DIVISION I GROUP F & G**
**OPERATING TEMP CODE T3C**
**PERFORMANCE DATA**

HP	RPM	Frame	Voltage	Frequency (Hz)	Full Load S.F.	Insulation Class	NEMA Design	Slip (%)	NEMA Code	Enclosure Type	IP Rating	Max. Ambient	Oper Temp Code	Max. KVAR
15	3538	254TC	208-230/460	60	1.15	F	B	1.7	G	TEXP	55	40° C	40° C	3.7

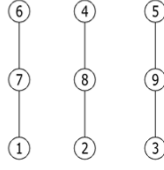
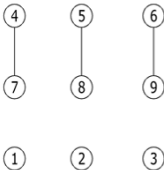
Amps (460V)		Max. Amps (208V)	Efficiency (%)					Power Factor			Torque (ft-lb)			DE Bearing	ODE Bearing	Connection	Weight (lbs.)
FLA	LRA	60HZ	100%	75%	50%	Min.	100%	75%	50%	FLT	LRT %	BDT %	6309	6309	9 Lead 2Δ/Δ	401	
16.5	116	36.49	91.0	90.0	89.0	89.5	0.860	0.872	0.819	22.4	130	200					

**NAME PLATE**

 										<b>CONNECTION DIAGRAMS</b>  <b>208V-230V</b> 						
<b>PREMIUM EFFICIENT EXPLOSION PROOF MOTOR</b>																
CAT NO:		PEXP254TC-15-2		FRAME		254TC		PHASE		3		<b>460V</b> 				
DE BRG		6309		ODE BRG		6309		CONN.		9 Lead 2Δ/Δ						
MAX AMB.		40° C		INS. CLASS		F		RATING		CONT		WEIGHT		401		
USABLE ON 208V 60HZ AT				36.5		MAX AMPS		SER								
DIVISION 1 CLASS I GROUP C D CLASS II GROUP F G						OPER TEMP CODE						40° C				
60 HERTZ DATA	HP		15		RPM		3538		HP		15		RPM		2948	
	VOLTS				208-230/460				VOLTS				190/380			
	F.L. AMPS				16.5				F.L. AMPS				39.9/20			
	S.F. AMPS				19.0				S.F. AMPS				39.9/20			
	S.F. 1.15 DESIGN B CODE G				S.F. 1.0 DESIGN B CODE H											
	NEMA NOM.EFF. 91.0 % P.F. 0.86				NEMA NOM.EFF. 91.0 % P.F. 0.86											
	NEMA MIN.EFF. 89.5 %				NEMA MIN.EFF. 89.4 %											
MAX. KVAR				3.7				LUB.				Mobil Polyrex EM				
<small>General purpose use on industrial machinery installed in damp, dusty or dirty environments. These motors are designed for use in hazardous locations defined by class and group.</small>										  		CC 041B				
Hernando, Mississippi																

	<b>ELECTRIC MOTORS FOR HAZARDOUS LOCATIONS</b> CLASS I DIVISION I GROUP C D, CLASS II DIVISION I GROUP F G NO. CCXXXXX E310089	
---	--	--

**APPLICATIONS:**

General purpose use on pumps, fans, blowers, compressors, conveyors, material handling and other industrial machinery installed in damp, dusty or dirty environments. These motors are designed to be used in hazardous locations as defined by class and group.