

PEXP213TC-7.5-4

EXPLOSION PROOF ELECTRIC MOTOR

NEMA PREMIUM EFFICIENCY

TOTALLY ENCLOSED FAN COOLED; EXPLOSION PROOF ENCLOSURE

CLASS I DIVISION I GROUP C & D; CLASS II DIVISION I GROUP F & G

OPERATING TEMP CODE T3C

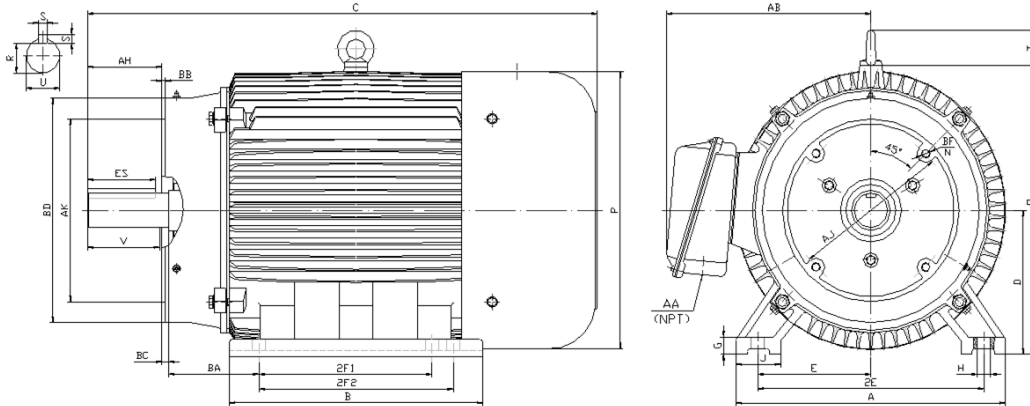

DIMENSIONS

HP	RPM	Frame	MOUNTING														
			A	B	C	D	G	H	J	E	2E	2F1	2F2	O	P	T	BA
7.5	1800	213TC	11.00	7.90	18.90	5.25	0.70	0.41	2.40	4.25	8.50	5.50	0.00	11.20	11.60	1.90	3.50

FLANGE							Shaft Extension, Key Set						Conduit Box		Bearings		Mount
AH	AJ	AK	BB	BC	BD	BF	U	V	R	S	ES	N-W	AA	AB	DE	ODE	
3.12	7.25	8.50	0.25	0.25	9.00	4*1/2-13	1.38	3.12	1.20	0.31	2.41	3.38	1.00	9.00	6308-ZZ	6308-ZZ	F1

BEARING LUBRICATION: The bearings come lubricated with Mobil Polyrex EM Polyurea Grease.



PEXP213TC-7.5-4

EXPLOSION PROOF ELECTRIC MOTOR

NEMA PREMIUM EFFICIENCY

TOTALLY ENCLOSED FAN COOLED; EXPLOSION PROOF ENCLOSURE

CLASS I DIVISION I GROUP C & D; CLASS II DIVISION I GROUP F & G







OPERATING TEMP CODE T3C

PERFORMANCE DATA

HP	RPM	Frame	Voltage	Frequency (Hz)	Full Load S.F.	Insulation Class	NEMA Design	Slip (%)	NEMA Code	Enclosure Type	IP Rating	Max. Ambient	Oper Temp Code	Max. KVAR
7.5	1773	213TC	208-230/460	60	1.15	F	B	1.5	H	TEXP	55	40° C	40° C	3

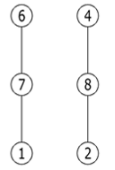
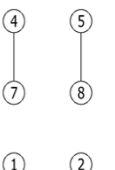
Amps (460V)		Max. Amps (208V)	Efficiency (%)				Power Factor			Torque (ft-lb)			DE Bearing	ODE Bearing	Connection	Weight (lbs.)
FLA	LRA	60HZ	100%	75%	50%	Min.	100%	75%	50%	FLT	LRT %	BDT %				
8.9	63.5	19.68	91.7	91.5	89.0	90.2	0.840	0.824	0.736	22.3	175	215	6308-ZZ	6308-ZZ	9 Lead 2Δ/Δ	254

NAME PLATE

 										CONNECTION DIAGRAMS 208V-230V 		
PREMIUM EFFICIENT EXPLOSION PROOF MOTOR												
CAT NO: PEXP213TC-7.5-4			FRAME 213TC			PHASE 3			460V 			
DE BRG 6308-ZZ		ODE BRG 6308-ZZ		CONN. 9 Lead 2Δ/Δ								
MAX AMB. 40° C		INS. CLASS F		RATING CONT		WEIGHT 254						
USABLE ON 208V 60HZ AT 19.7				MAX AMPS		SER						
DIVISION 1 CLASS I GROUP C D CLASS II GROUP F G						OPER TEMP CODE 40° C						
60 HERTZ DATA	HP 7.5		RPM 1773		HP 7.5		RPM 1478					
	VOLTS 208-230/460				VOLTS 190/380							
	F.L. AMPS 8.9				F.L. AMPS 21.5/10.8							
	S.F. AMPS 10.2				S.F. AMPS 21.5/10.8							
	S.F. 1.15 DESIGN B CODE H				S.F. 1.0 DESIGN B CODE J							
	NEMA NOM.EFF. 91.7 % P.F. 0.84				NEMA NOM.EFF. 91.7 % P.F. 0.84							
	NEMA MIN.EFF. 90.2 %				NEMA MIN.EFF. 87.5 %							
MAX. KVAR 3			LUB. Mobil Polyrex EM									
<small>General purpose use on industrial machinery installed in damp, dusty or dirty environments. These motors are designed for use in hazardous locations defined by class and group.</small>    CC 041B												
<small>Hernando, Mississippi</small>												



ELECTRIC MOTORS FOR HAZARDOUS LOCATIONS
 CLASS I DIVISION I GROUP C D, CLASS II DIVISION I GROUP F G
 NO. CCXXXXX E310089

APPLICATIONS:

General purpose use on pumps, fans, blowers, compressors, conveyors, material handling and other industrial machinery installed in damp, dusty or dirty environments. These motors are designed to be used in hazardous locations as defined by class and group.