

PEXP213TC-7.5-2

EXPLOSION PROOF ELECTRIC MOTOR

NEMA PREMIUM EFFICIENCY

TOTALLY ENCLOSED FAN COOLED; EXPLOSION PROOF ENCLOSURE

CLASS I DIVISION I GROUP C & D; CLASS II DIVISION I GROUP F & G

OPERATING TEMP CODE T3C

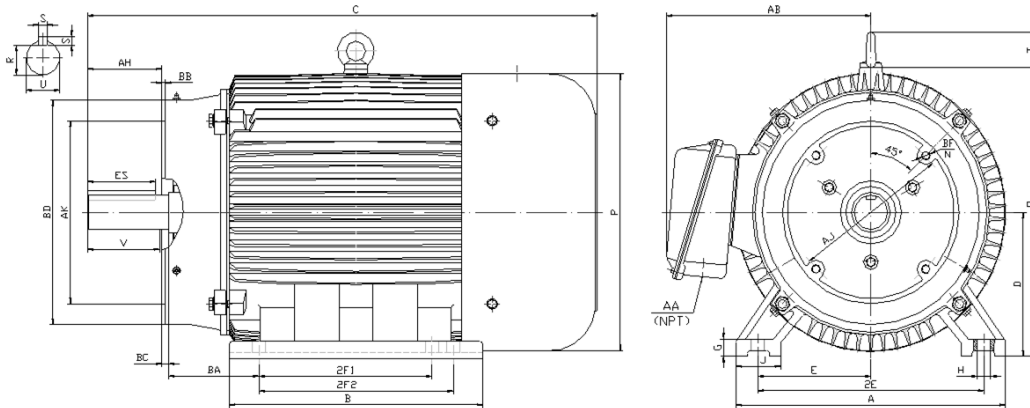

DIMENSIONS

HP	RPM	Frame	MOUNTING														
			A	B	C	D	G	H	J	E	2E	2F1	2F2	O	P	T	BA
7.5	3600	213TC	11.00	7.90	18.90	5.25	0.70	0.41	2.40	4.25	8.50	5.50	0.00	11.20	11.60	1.90	3.50

FLANGE							Shaft Extension, Key Set						Conduit Box		Bearings		Mount
AH	AJ	AK	BB	BC	BD	BF	U	V	R	S	ES	N-W	AA	AB	DE	ODE	
3.12	7.25	8.50	0.25	0.25	9.00	4*1/2-13	1.38	3.12	1.20	0.31	2.41	3.38	1.00	9.00	6308-ZZ	6308-ZZ	F1

BEARING LUBRICATION: The bearings come lubricated with Mobil Polyrex EM Polyurea Grease.



PEXP213TC-7.5-2

EXPLOSION PROOF ELECTRIC MOTOR

NEMA PREMIUM EFFICIENCY

TOTALLY ENCLOSED FAN COOLED; EXPLOSION PROOF ENCLOSURE

CLASS I DIVISION I GROUP C & D; CLASS II DIVISION I GROUP F & G







OPERATING TEMP CODE T3C

PERFORMANCE DATA

HP	RPM	Frame	Voltage	Frequency (Hz)	Full Load S.F.	Insulation Class	NEMA Design	Slip (%)	NEMA Code	Enclosure Type	IP Rating	Max. Ambient	Oper Temp Code	Max. KVAR
7.5	3539	213TC	208-230/460	60	1.15	F	B	1.7	H	TEXP	55	40° C	40° C	1.8

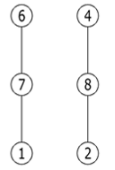
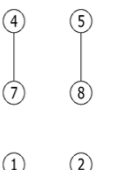
Amps (460V)		Max. Amps (208V)	Efficiency (%)				Power Factor			Torque (ft-lb)			DE Bearing	ODE Bearing	Connection	Weight (lbs.)
FLA	LRA	60HZ	100%	75%	50%	Min.	100%	75%	50%	FLT	LRT %	BDT %				
8.3	63.5	18.36	89.5	90.0	85.0	87.5	0.860	0.897	0.846	11.17	140	200	6308-ZZ	6308-ZZ	9 Lead 2Δ/Δ	253

NAME PLATE

 North American Electric, Inc.															CONNECTION DIAGRAMS 208V-230V 		
PREMIUM EFFICIENT EXPLOSION PROOF MOTOR																	
CAT NO: PEXP213TC-7.5-2			FRAME 213TC			PHASE 3											
DE BRG 6308-ZZ		ODE BRG 6308-ZZ		CONN. 9 Lead 2Δ/Δ													
MAX AMB. 40° C		INS. CLASS F		RATING CONT		WEIGHT 253											
USABLE ON 208V 60HZ AT 18.4				MAX AMPS		SER											
DIVISION 1 CLASS I GROUP C D CLASS II GROUP F G						OPER TEMP CODE 40° C											
60 HERTZ DATA	HP 7.5		RPM 3539		HP 7.5		RPM 2949		50 HERTZ DATA								
	VOLTS 208-230/460				VOLTS 190/380												
	F.L. AMPS 8.3				F.L. AMPS 20.1/10.1												
	S.F. AMPS 9.5				S.F. AMPS 20.1/10.1												
	S.F. 1.15 DESIGN B CODE H				S.F. 1.0 DESIGN B CODE J												
	NEMA NOM.EFF. 89.5 % P.F. 0.86				NEMA NOM.EFF. 89.5 % P.F. 0.86												
	NEMA MIN.EFF. 87.5 %				NEMA MIN.EFF. 87.0 %												
MAX. KVAR 1.8				LUB. Mobil Polyrex EM				460V 									
<small>General purpose use on industrial machinery installed in damp, dusty or dirty environments. These motors are designed for use in hazardous locations defined by class and group.</small> Hernando, Mississippi										   CC 041B							



ELECTRIC MOTORS FOR HAZARDOUS LOCATIONS
CLASS I DIVISION I GROUP C D, CLASS II DIVISION I GROUP F G
NO. CCXXXXX E310089

APPLICATIONS:

General purpose use on pumps, fans, blowers, compressors, conveyors, material handling and other industrial machinery installed in damp, dusty or dirty environments. These motors are designed to be used in hazardous locations as defined by class and group.