

PEXP184TC-5-2

EXPLOSION PROOF ELECTRIC MOTOR

NEMA PREMIUM EFFICIENCY

TOTALLY ENCLOSED FAN COOLED; EXPLOSION PROOF ENCLOSURE

CLASS I DIVISION I GROUP C & D; CLASS II DIVISION I GROUP F & G

OPERATING TEMP CODE T3C

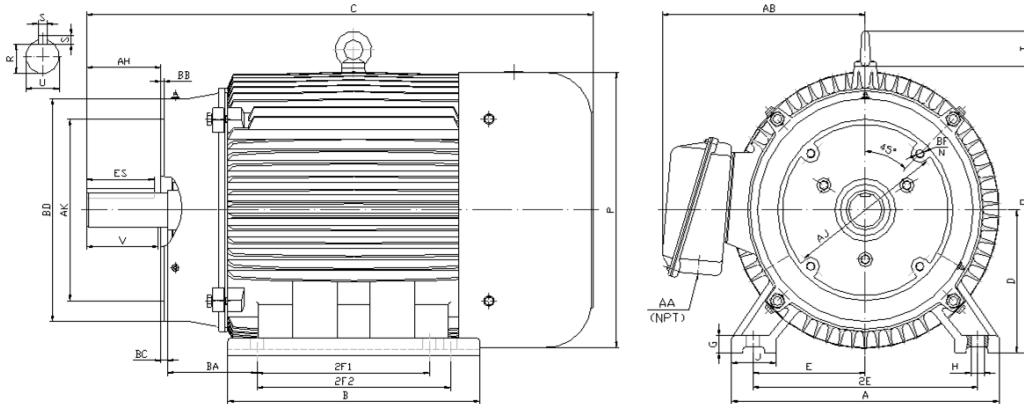

DIMENSIONS

HP	RPM	Frame	MOUNTING														
			A	B	C	D	G	H	J	E	2E	2F1	2F2	O	P	T	BA
5	3600	184TC	9.50	8.30	17.10	4.50	0.60	0.41	2.00	3.75	7.50	4.50	5.50	9.10	8.70	1.60	2.75

FLANGE							Shaft Extension, Key Set						Conduit Box		Bearings		Mount
AH	AJ	AK	BB	BC	BD	BF	U	V	R	S	ES	N-W	AA	AB	DE	ODE	
2.62	7.25	8.50	0.25	0.12	9.00	4*1/2-13	1.13	2.50	0.99	0.25	1.78	2.75	0.75	7.50	6306-ZZ	6306-ZZ	F1

BEARING LUBRICATION: The bearings come lubricated with Mobil Polyrex EM Polyurea Grease.









PEXP184TC-5-2
EXPLOSION PROOF ELECTRIC MOTOR
NEMA PREMIUM EFFICIENCY
TOTALLY ENCLOSED FAN COOLED; EXPLOSION PROOF ENCLOSURE
CLASS I DIVISION I GROUP C & D; CLASS II DIVISION I GROUP F & G
OPERATING TEMP CODE T3C
PERFORMANCE DATA

HP	RPM	Frame	Voltage	Frequency (Hz)	Full Load S.F.	Insulation Class	NEMA Design	Slip (%)	NEMA Code	Enclosure Type	IP Rating	Max. Ambient	Oper Temp Code	Max. KVAR
5	3543	184TC	208-230/460	60	1.15	F	B	1.6	J	TEXP	55	40° C	40° C	1.5

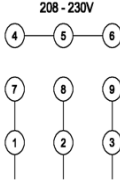
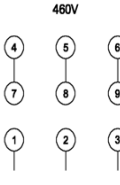
Amps (460V)		Max. Amps (208V)	Efficiency (%)				Power Factor			Torque (ft-lb)			DE Bearing	ODE Bearing	Connection	Weight (lbs.)
FLA	LRA	60HZ	100%	75%	50%	Min.	100%	75%	50%	FLT	LRT %	BDT %				
6	46	13.27	88.5	87.0	85.0	86.5	0.850	0.845	0.822	7.41	150	215	6306-ZZ	6306-ZZ	9 Lead 2Y/Y	128

NAME PLATE

 										CONNECTION DIAGRAMS 	
PREMIUM EFFICIENT EXPLOSION PROOF MOTOR											
CAT NO: PEXP184TC-5-2			FRAME 184TC			PHASE 3					
DE BRG 6306-ZZ		ODE BRG 6306-ZZ		CONN. 9 Lead 2Y/Y							
MAX AMB. 40° C		INS. CLASS F		RATING CONT		WEIGHT 128					
USABLE ON 208V 60HZ AT 13.3			MAX AMPS		SER						
DIVISION 1 CLASS I GROUP C D CLASS II GROUP F G						OPER TEMP CODE 40° C					
60 HERTZ DATA	HP 5		RPM 3543		HP 5		RPM 2953				50 HERTZ DATA
	VOLTS 208-230/460				VOLTS 190/380						
	F.L. AMPS 6				F.L. AMPS 14.5/7.3						
	S.F. AMPS 6.9				S.F. AMPS 14.5/7.3						
	S.F. 1.15 DESIGN B CODE J				S.F. 1.0 DESIGN B CODE K						
	NEMA NOM.EFF. 88.5 % P.F. 0.85				NEMA NOM.EFF. 88.5 % P.F. 0.85						
	NEMA MIN.EFF. 86.5 %				NEMA MIN.EFF. 85.5 %						
MAX. KVAR 1.5				LUB. Mobil Polyrex EM							
<small>General purpose use on industrial machinery installed in damp, dusty or dirty environments. These motors are designed for use in hazardous locations defined by class and group.</small>    CC 041B											
ELECTRIC MOTORS FOR HAZARDOUS LOCATIONS CLASS I DIVISION I GROUP C D, CLASS II DIVISION I GROUP F G NO. CCXXXXX E310089											

APPLICATIONS:

General purpose use on pumps, fans, blowers, compressors, conveyors, material handling and other industrial machinery installed in damp, dusty or dirty environments. These motors are designed to be used in hazardous locations as defined by class and group.