

**PEXP145TC-2-4**

**EXPLOSION PROOF ELECTRIC MOTOR**

**NEMA PREMIUM EFFICIENCY**

**TOTALLY ENCLOSED FAN COOLED; EXPLOSION PROOF ENCLOSURE**

**CLASS I DIVISION I GROUP C & D; CLASS II DIVISION I GROUP F & G**

**OPERATING TEMP CODE T3C**

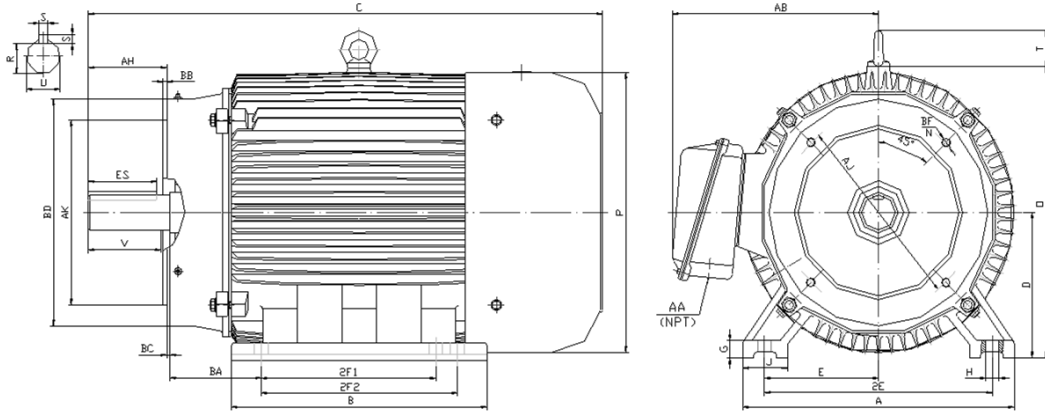

**DIMENSIONS**

HP	RPM	Frame	MOUNTING														
			A	B	C	D	G	H	J	E	2E	2F1	2F2	O	P	T	BA
2	1800	145TC	7.00	6.20	14.60	3.50	0.50	0.34	1.40	2.75	5.50	4.00	5.00	7.10	6.95	0.00	2.25

FLANGE							Shaft Extension, Key Set						Conduit Box		Bearings		Mount
AH	AJ	AK	BB	BC	BD	BF	U	V	R	S	ES	N-W	AA	AB	DE	ODE	
2.12	5.88	4.50	0.16	0.12	6.50	4*3/8-16	0.88	2.00	0.77	0.19	1.41	2.25	0.75	6.10	6205-ZZ	6205-ZZ	F1

**BEARING LUBRICATION: The bearings come lubricated with Mobil Polyrex EM Polyurea Grease.**









**PEXP145TC-2-4**
**EXPLOSION PROOF ELECTRIC MOTOR**
**NEMA PREMIUM EFFICIENCY**
**TOTALLY ENCLOSED FAN COOLED; EXPLOSION PROOF ENCLOSURE**
**CLASS I DIVISION I GROUP C & D; CLASS II DIVISION I GROUP F & G**
**OPERATING TEMP CODE T3C**
**PERFORMANCE DATA**

HP	RPM	Frame	Voltage	Frequency (Hz)	Full Load S.F.	Insulation Class	NEMA Design	Slip (%)	NEMA Code	Enclosure Type	IP Rating	Max. Ambient	Oper Temp Code	Max. KVAR
2	1765	145TC	208-230/460	60	1.15	F	B	1.9	L	TEXP	55	40° C	40° C	1.2

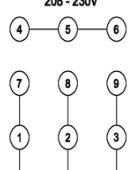
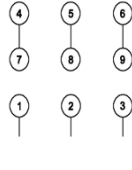
Amps (460V)		Max. Amps (208V)	Efficiency (%)				Power Factor			Torque (ft-lb)			DE Bearing	ODE Bearing	Connection	Weight (lbs.)
FLA	LRA	60HZ	100%	75%	50%	Min.	100%	75%	50%	FLT	LRT %	BDT %				
2.6	25	5.75	86.5	86.0	84.0	84	0.800	0.706	0.577	6	235	270	6205-ZZ	6205-ZZ	9 Lead 2Y/Y	88

**NAME PLATE**

 <b>North American Electric, Inc.</b>												<b>CONNECTION DIAGRAMS</b>  <b>208 - 230V</b>   <b>460V</b> 											
<b>PREMIUM EFFICIENT EXPLOSION PROOF MOTOR</b>																							
CAT NO: PEXP145TC-2-4			FRAME 145TC			PHASE 3			DE BRG 6205-ZZ									ODE BRG 6205-ZZ			CONN. 9 Lead 2Y/Y		
MAX AMB. 40° C			INS. CLASS F			RATING CONT			WEIGHT 88									USABLE ON 208V 60HZ AT 5.8			MAX AMPS SER		
DIVISION 1 CLASS I GROUP C D CLASS II GROUP F G						OPER TEMP CODE 40° C																	
60 HERTZ DATA		HP 2		RPM 1765		HP 2		RPM 1471		50 HERTZ DATA													
		VOLTS 208-230/460				VOLTS 190/380																	
		F.L. AMPS 2.6				F.L. AMPS 6.3/3.2																	
		S.F. AMPS 3.0				S.F. AMPS 6.3/3.2																	
		S.F. 1.15 DESIGN B CODE L				S.F. 1.0 DESIGN B CODE M																	
		NEMA NOM.EFF. 86.5 % P.F. 0.80				NEMA NOM.EFF. 86.5 % P.F. 0.8																	
		NEMA MIN.EFF. 84.0 %				NEMA MIN.EFF. 82.4 %																	
MAX. KVAR 1.2				LUB. Mobil Polyrex EM																			
<small>General purpose use on industrial machinery installed in damp, dusty or dirty environments. These motors are designed for use in hazardous locations defined by class and group.</small>    <span style="float: right;">CC 041B</span>																							
Hernando, Mississippi																							

	<b>ELECTRIC MOTORS FOR HAZARDOUS LOCATIONS</b> <b>CLASS I DIVISION I GROUP C D, CLASS II DIVISION I GROUP F G</b> NO. CCXXXXX E310089
---	---

**APPLICATIONS:**

General purpose use on pumps, fans, blowers, compressors, conveyors, material handling and other industrial machinery installed in damp, dusty or dirty environments. These motors are designed to be used in hazardous locations as defined by class and group.