

PEXP286T-20-6

EXPLOSION PROOF ELECTRIC MOTOR

NEMA PREMIUM EFFICIENCY

TOTALLY ENCLOSED FAN COOLED; EXPLOSION PROOF ENCLOSURE

CLASS I DIVISION I GROUP C & D; CLASS II DIVISION I GROUP F & G

OPERATING TEMP CODE T3C

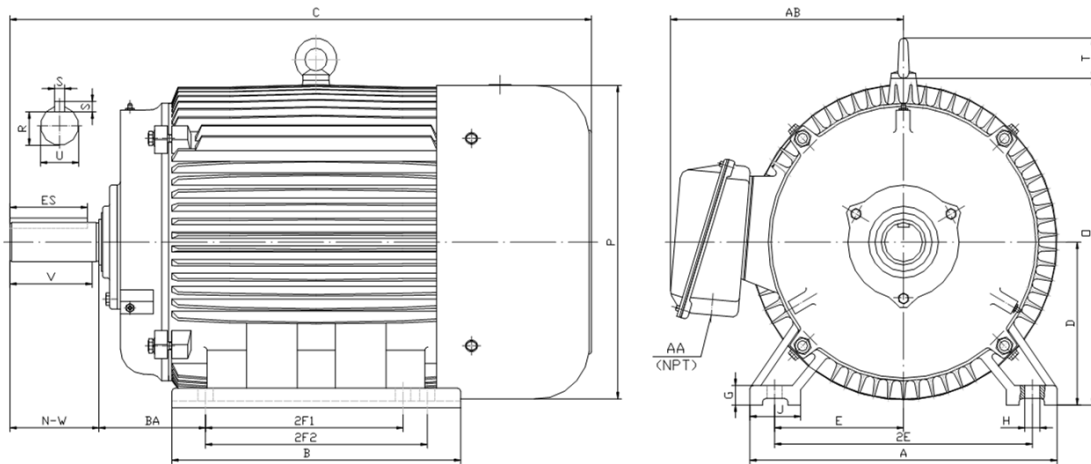

DIMENSIONS

HP	RPM	Frame	MOUNTING														
			A	B	C	D	G	H	J	E	2E	2F1	2F2	O	P	T	BA
20	1200	286T	14.00	13.20	28.10	7.00	0.85	0.53	2.75	5.50	11.00	9.50	11.00	14.50	14.00	2.20	4.75

Shaft Extension, Key Set						Conduit Box		Bearings		Mount
U	V	R	S	ES	N-W	AA	AB	DE	ODE	
1.88	4.38	1.59	0.50	3.28	4.62	1.50	11.30	6310	6310	F1

BEARING LUBRICATION: The bearings come lubricated with Mobil Polyrex EM Polyurea Grease. It is recommended that you add some additional lubrication when the motor is installed.

Three options (brands) for suitable lubrication include, but are not limited to, the following:

- 1.) Mobil Polyrex EM
- 2.) Citco Polyurea MP
- 3.) Conoco Phillips Polytac EP









PEXP286T-20-6
EXPLOSION PROOF ELECTRIC MOTOR
NEMA PREMIUM EFFICIENCY
TOTALLY ENCLOSED FAN COOLED; EXPLOSION PROOF ENCLOSURE
CLASS I DIVISION I GROUP C & D; CLASS II DIVISION I GROUP F & G
OPERATING TEMP CODE T3C
PERFORMANCE DATA

HP	RPM	Frame	Voltage	Frequency (Hz)	Full Load S.F.	Insulation Class	NEMA Design	Slip (%)	NEMA Code	Enclosure Type	IP Rating	Max. Ambient	Oper Temp Code	Max. KVAR
20	1179	286T	208-230/460	60	1.15	F	B	1.8	G	TEXP	55	40° C	T3C	6.5

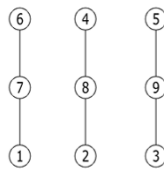
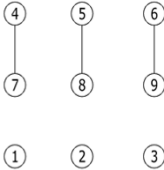
Amps (460V)		Max. Amps (208V)	Efficiency (%)				Power Factor			Torque (ft-lb)			DE Bearing	ODE Bearing	Connection	Weight (lbs.)
FLA	LRA	60HZ	100%	75%	50%	Min.	100%	75%	50%	FLT	LRT %	BDT %				
23.5	145.0	52.0	91.7	91.5	89.0	90.2	0.81	0.79	0.72	89.1	135	200	6310	6310	9 Lead 2Δ/Δ	520

NAME PLATE

 North American Electric, Inc.															CONNECTION DIAGRAMS 208V-230V 				
PREMIUM EFFICIENT EXPLOSION PROOF MOTOR																			
CAT NO: PEXP286T-20-6			FRAME 286T			PHASE 3													
DE BRG 6310		ODE BRG 6310		CONN. 9 Lead 2Δ/Δ															
MAX AMB. 40° C		INS. CLASS F		RATING CONT		WEIGHT 520													
USABLE ON 208V 60HZ AT 52.0				MAX AMPS		SER													
DIVISION 1 CLASS I GROUP C D CLASS II GROUP F G						OPER TEMP CODE T3C													
60 HERTZ DATA	HP 20		RPM 1179		HP 20		RPM 983		50 HERTZ DATA										
	VOLTS 208-230/460				VOLTS 190/380														
	F.L. AMPS 52 - 47 / 23.5				F.L. AMPS 56.9/28.5														
	S.F. AMPS 27.0				S.F. AMPS 56.9/28.5														
	S.F. 1.15 DESIGN B CODE G				S.F. 1.0 DESIGN B CODE H														
	NEMA NOM.EFF. 91.7 % P.F. 0.81				NEMA NOM.EFF. 91.2 % P.F. 0.81														
	NEMA MIN.EFF. 90.2 %				NEMA MIN.EFF. 89.4 %														
MAX. KVAR 6.5		LUB. Mobil Polyrex EM						460V 											
<small>General purpose use on industrial machinery installed in damp, dusty or dirty environments. These motors are designed for use in hazardous locations defined by class and group.</small>										   CC 041B									
Hernando, Mississippi																			

	ELECTRIC MOTORS FOR HAZARDOUS LOCATIONS
	<small>CLASS I DIVISION I GROUP C D, CLASS II DIVISION I GROUP F G NO. CCXXXXX E310089</small>

APPLICATIONS:

General purpose use on pumps, fans, blowers, compressors, conveyors, material handling and other industrial machinery installed in damp, dusty or dirty environments. These motors are designed to be used in hazardous locations as defined by class and group.