

PEXP213T-3-6

EXPLOSION PROOF ELECTRIC MOTOR

NEMA PREMIUM EFFICIENCY

TOTALLY ENCLOSED FAN COOLED; EXPLOSION PROOF ENCLOSURE

CLASS I DIVISION I GROUP C & D; CLASS II DIVISION I GROUP F & G

OPERATING TEMP CODE T3C

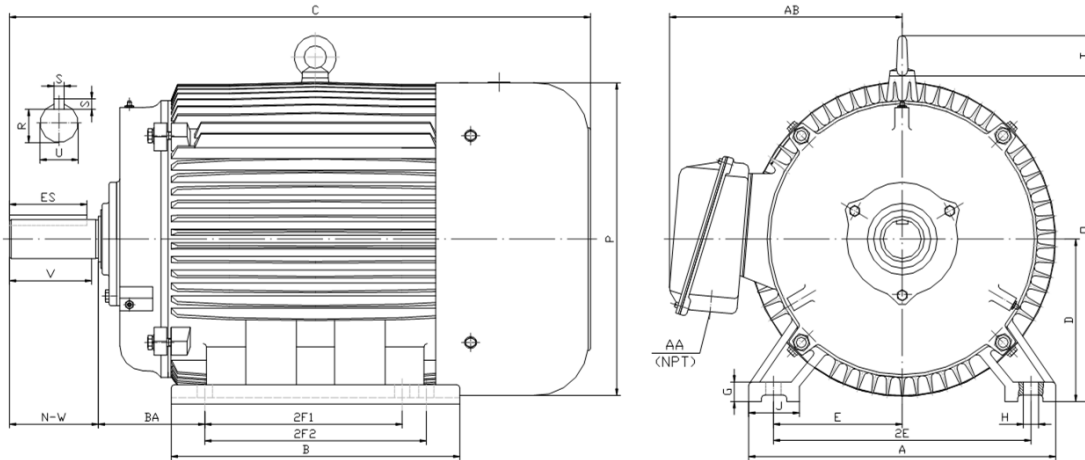

DIMENSIONS

HP	RPM	Frame	MOUNTING														
			A	B	C	D	G	H	J	E	2E	2F1	2F2	O	P	T	BA
3	1200	213T	11.00	7.90	18.90	5.25	0.70	0.41	2.40	4.25	8.50	5.50	0.00	11.20	11.60	1.90	3.50

Shaft Extension, Key Set						Conduit Box		Bearings		Mount
U	V	R	S	ES	N-W	AA	AB	DE	ODE	
1.375	3.120	1.201	0.312	2.410	3.380	1.00	9.00	6308-ZZ	6308-ZZ	F1

BEARING LUBRICATION: The bearings come lubricated with Mobil Polyrex EM Polyurea Grease.









PEXP213T-3-6
EXPLOSION PROOF ELECTRIC MOTOR
NEMA PREMIUM EFFICIENCY
TOTALLY ENCLOSED FAN COOLED; EXPLOSION PROOF ENCLOSURE
CLASS I DIVISION I GROUP C & D; CLASS II DIVISION I GROUP F & G
OPERATING TEMP CODE T3C
PERFORMANCE DATA

HP	RPM	Frame	Voltage	Frequency (Hz)	Full Load S.F.	Insulation Class	NEMA Design	Slip (%)	NEMA Code	Enclosure Type	IP Rating	Max. Ambient	Oper Temp Code	Max. KVAR
3	1182	213T	208-230/460	60	1.15	F	B	1.5	K	TEXP	55	40° C	T3C	1.8

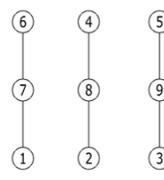
Amps (460V)		Max. Amps (208V)	Efficiency (%)				Power Factor			Torque (ft-lb)			DE Bearing	ODE Bearing	Connection	Weight (lbs.)
FLA	LRA	60HZ	100%	75%	50%	Min.	100%	75%	50%	FLT	LRT %	BDT %	6308-ZZ	6308-ZZ	9 Lead 2Δ/Δ	238
4.0	32.0	8.7	89.5	89.0	87.5	87.5	0.71	0.65	0.53	13.3	155	230				

NAME PLATE

 North American Electric, Inc.															CONNECTION DIAGRAMS 208V-230V 		
PREMIUM EFFICIENT EXPLOSION PROOF MOTOR																	
CAT NO:		PEXP213T-3-6			FRAME		213T		PHASE		3						
DE BRG		6308-ZZ		ODE BRG		6308-ZZ		CONN.		9 Lead 2Δ/Δ							
MAX AMB.		40° C		INS. CLASS		F		RATING		CONT		WEIGHT		238			
USABLE ON 208V 60HZ AT				8.7		MAX AMPS		SER									
DIVISION 1 CLASS I GROUP C D CLASS II GROUP F G							OPER TEMP CODE					T3C					
60 HERTZ DATA	HP		3		RPM		1182		HP		3		RPM		985		
	VOLTS				208-230/460				VOLTS				190/380				
	F.L. AMPS				8.7 - 7.9 / 3.95				F.L. AMPS				9.6/4.8				
	S.F. AMPS				4.5				S.F. AMPS				9.6/4.8				
	S.F. 1.15 DESIGN				B CODE K				S.F. 1.0 DESIGN				B CODE L				
	NEMA NOM.EFF.				89.5 % P.F. 0.71				NEMA NOM.EFF.				84.4 % P.F. 0.71				
	NEMA MIN.EFF.				87.5 %				NEMA MIN.EFF.				81.3 %				
	MAX. KVAR		1.8		LUB.				Mobil Polyrex EM								
<small>General purpose use on industrial machinery installed in damp, dusty or dirty environments. These motors are designed for use in hazardous locations defined by class and group.</small>																CC 041B	
Hernando, Mississippi																	

	ELECTRIC MOTORS FOR HAZARDOUS LOCATIONS
	CLASS I DIVISION I GROUP C D, CLASS II DIVISION I GROUP F G
	NO. CCXXXXX E310089

APPLICATIONS:

General purpose use on pumps, fans, blowers, compressors, conveyors, material handling and other industrial machinery installed in damp, dusty or dirty environments. These motors are designed to be used in hazardous locations as defined by class and group.