

PEXP184T-2-6

EXPLOSION PROOF ELECTRIC MOTOR

NEMA PREMIUM EFFICIENCY

TOTALLY ENCLOSED FAN COOLED; EXPLOSION PROOF ENCLOSURE

CLASS I DIVISION I GROUP C & D; CLASS II DIVISION I GROUP F & G

OPERATING TEMP CODE T3C

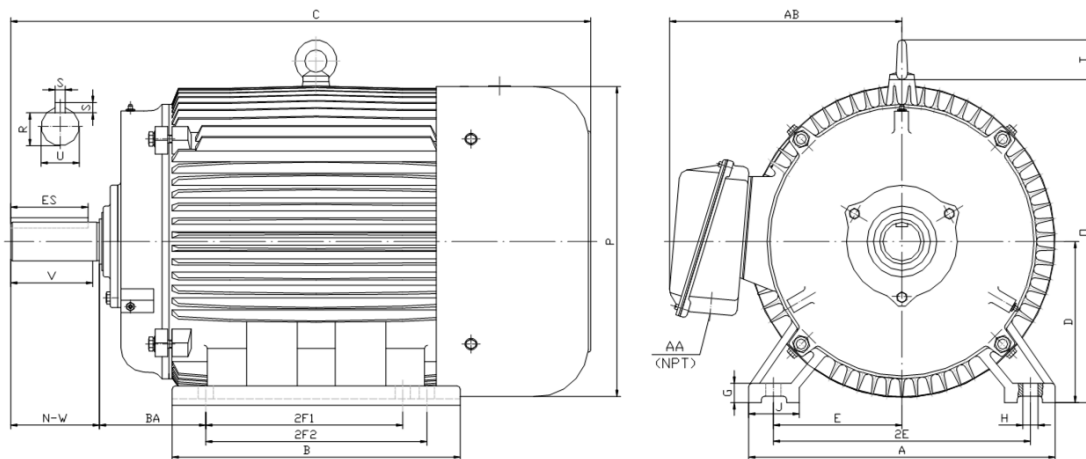

DIMENSIONS

HP	RPM	Frame	MOUNTING														
			A	B	C	D	G	H	J	E	2E	2F1	2F2	O	P	T	BA
2	1200	184T	9.50	8.30	17.10	4.50	0.60	0.41	2.00	3.75	7.50	4.50	5.50	9.10	8.70	1.60	2.75

Shaft Extension, Key Set						Conduit Box		Bearings		Mount
U	V	R	S	ES	N-W	AA	AB	DE	ODE	
1.125	2.50	0.986	0.250	1.78	2.75	0.75	7.50	6306-ZZ	6306-ZZ	F1

BEARING LUBRICATION: The bearings come lubricated with Mobil Polyrex EM Polyurea Grease.









PEXP184T-2-6
EXPLOSION PROOF ELECTRIC MOTOR
NEMA PREMIUM EFFICIENCY
TOTALLY ENCLOSED FAN COOLED; EXPLOSION PROOF ENCLOSURE
CLASS I DIVISION I GROUP C & D; CLASS II DIVISION I GROUP F & G
OPERATING TEMP CODE T3C
PERFORMANCE DATA

HP	RPM	Frame	Voltage	Frequency (Hz)	Full Load S.F.	Insulation Class	NEMA Design	Slip (%)	NEMA Code	Enclosure Type	IP Rating	Max. Ambient	Oper Temp Code	Max. KVAR
2	1183	184T	208-230/460	60	1.15	F	B	1.4	L	TEXP	55	40° C	T3C	1.4

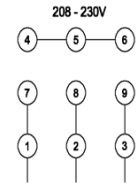
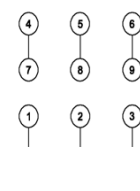
Amps (460V)		Max. Amps (208V)	Efficiency (%)				Power Factor			Torque (ft-lb)			DE Bearing	ODE Bearing	Connection	Weight (lbs.)
FLA	LRA	60HZ	100%	75%	50%	Min.	100%	75%	50%	FLT	LRT %	BDT %				
2.8	25.0	6.2	88.5	88.0	86.0	86.5	0.73	0.69	0.56	8.9	160	240	6306-ZZ	6306-ZZ	9 Lead 2Y/Y	130

NAME PLATE

 North American Electric, Inc.															CONNECTION DIAGRAMS 208 - 230V  460V 				
PREMIUM EFFICIENT EXPLOSION PROOF MOTOR																			
CAT NO: PEXP184T-2-6			FRAME 184T			PHASE 3													
DE BRG 6306-ZZ		ODE BRG 6306-ZZ		CONN. 9 Lead 2Y/Y															
MAX AMB. 40° C		INS. CLASS F		RATING CONT		WEIGHT 130													
USABLE ON 208V 60HZ AT 6.2			MAX AMPS		SER														
DIVISION 1 CLASS I GROUP C D CLASS II GROUP F G						OPER TEMP CODE T3C													
60 HERTZ DATA	HP 2		RPM 1183		HP 2		RPM 986		50 HERTZ DATA										
	VOLTS 208-230/460				VOLTS 190/380														
	F.L. AMPS 6.2 - 5.6 / 2.8				F.L. AMPS 6.8/3.4														
	S.F. AMPS 3.2				S.F. AMPS 6.8/3.4														
	S.F. 1.15 DESIGN B CODE L				S.F. 1.0 DESIGN B CODE M														
	NEMA NOM.EFF. 88.5 % P.F. 0.73				NEMA NOM.EFF. 82.5 % P.F. 0.73														
	NEMA MIN.EFF. 86.5 %				NEMA MIN.EFF. 79.0 %														
MAX. KVAR 1.4		LUB. Mobil Polyrex EM																	
<small>General purpose use on industrial machinery installed in damp, dusty or dirty environments. These motors are designed for use in hazardous locations defined by class and group.</small>    CC 041B Hernando, Mississippi																			

	ELECTRIC MOTORS FOR HAZARDOUS LOCATIONS CLASS I DIVISION I GROUP C D, CLASS II DIVISION I GROUP F G NO. CCXXXXX E310089
---	---

APPLICATIONS:

General purpose use on pumps, fans, blowers, compressors, conveyors, material handling and other industrial machinery installed in damp, dusty or dirty environments. These motors are designed to be used in hazardous locations as defined by class and group.