

PE286JP-30-2

CLOSE COUPLED PUMP MOTORS

NEMA PREMIUM EFFICIENCY

THREE PHASE, TOTALLY ENCLOSED FAN COOLED, JP FRAME

INVERTER DUTY 10:1 CT; 20:1 VT - NEMA MG1 PART 31

Factory Certified for T2B Class I, Division II, Groups A,B,C & D and Class II, Division II, Groups F & G

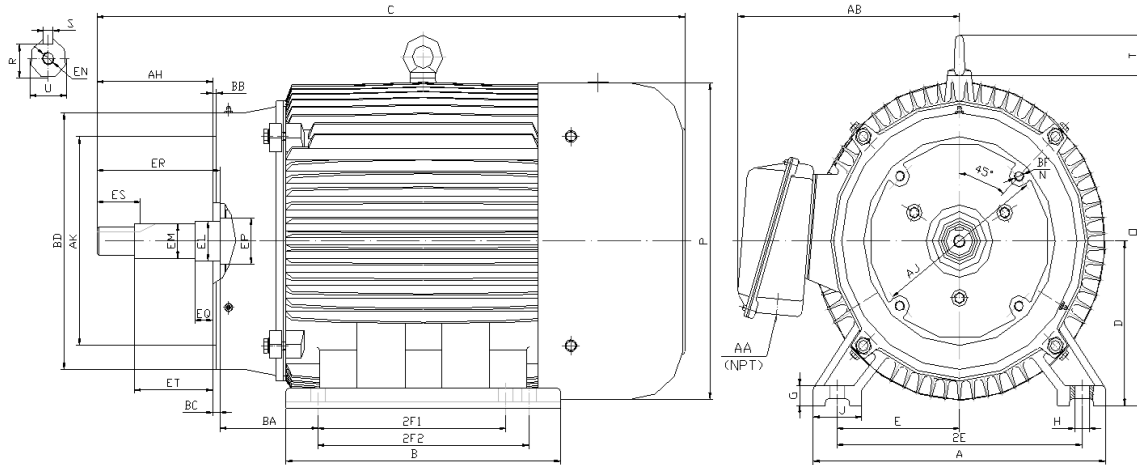

DIMENSIONS

HP	RPM	Frame	MOUNTING														
			A	B	C	D	G	H	J	E	2E	2F1	2F2	O	P	T	BA
30	3600	286JP	14.00	13.20	31.85	7.00	0.85	0.53	2.75	5.50	11.00	9.50	11.00	14.50	14.00	2.20	4.75

FLANGE							Shaft Extension, Key Set										
AK	AJ	AH	BB	BC	BD	N*BF	U	R	S	EQ	ER	ES	ET	EP	EL	EM	EN
12.500	11.00	8.156	0.312	0.25	14.0	4*5/8-11	1.2495	1.112	0.252	2.390	8.13	2.53	5.895	2.16	1.750	1.3750	1/2-13
12.495		8.094	0.250				1.2490	1.097	0.250	2.360			5.855		1.748	1.3745	

Conduit Box		Bearings		Mount
AA	AB	DE	ODE	
1.50	11.30	6311	6311	F1

BEARING LUBRICATION: The bearings come lubricated with Mobil Polyrex EM Polyurea Grease.





PE286JP-30-2

CLOSE COUPLED PUMP MOTORS

NEMA PREMIUM EFFICIENCY

THREE PHASE, TOTALLY ENCLOSED FAN COOLED, JP FRAME

INVERTER DUTY 10:1 CT; 20:1 VT - NEMA MG1 PART 31







Factory Certified for T2B Class I, Division II, Groups A,B,C & D and Class II, Division II, Groups F & G

PERFORMANCE DATA

HP	RPM	Frame	Voltage	Frequency (Hz)	Full Load S.F.	Insulation Class	NEMA Design	Slip (%)	NEMA Code	Enclosure Type	IP Rating	Max. Ambient
30	3530	286JP	208-230/460	60	1.15	F	B	1.9	G	TEFC	55	40° C

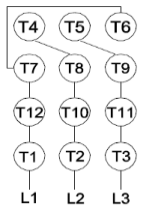
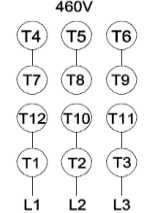
Amps (460V)		Efficiency (%)				Power Factor			Torque (ft-lb)			DE Bearing	ODE Bearing	Connection	Weight (lbs.)
FLA	LRA	100%	75%	50%	Min.	100%	75%	50%	FLT	LRT %	BDT %				
34.5	217.0	91.7	91.5	90.5	90.2	0.900	0.870	0.800	44.5	150	260	6311	6311	12 Lead 2Δ/Δ	412

NAME PLATE

 North American Electric, Inc.													CONNECTION DIAGRAMS 208-230V 		
INVERTER DUTY 20:1 VT; 10:1 CT										CLOSE COUPLED PUMP MOTOR					
CAT NO: PE286JP-30-2			FRAME 286JP			PHASE 3									
HZ 60	S.F. 1.15	HZ 50	S.F. 1.0	ENCL TEFC	IP 55										
HP 30	RPM 3530	HP 30	RPM 2920	DUTY CONT	DES B										
VOLTS 208-230/460			VOLTS 190/380			AMB 40° C			INS F						
FLA 74 - 69 / 34.5			FLA 82/41			DE BEARING 6311									
CODE G		P.F. 0.90		CODE F		P.F. 0.91		ODE BEARING 6311							
EFF 91.7		MIN 90.2		EFF 90		MIN 88.5		LUB: Mobil Polyrex EM							
MOTOR WEIGHT 412 LBS			CONNECTION 12 Lead 2Δ/Δ			SER NO						460V 			
Specifically designed for use on industrial and commercial pumping units. Hernando, Mississippi										  			CC 082A		

APPLICATIONS:

Specifically designed for use on industrial and commercial pumping units.