

PE326TS-60-2-ODP

GENERAL PURPOSE ELECTRIC MOTOR
NEMA PREMIUM EFFICIENCY
CAST IRON CONSTRUCTION - OPEN DRIP PROOF
INVERTER DUTY 10:1 CT; 20:1 VT - NEMA MG1 PART 31

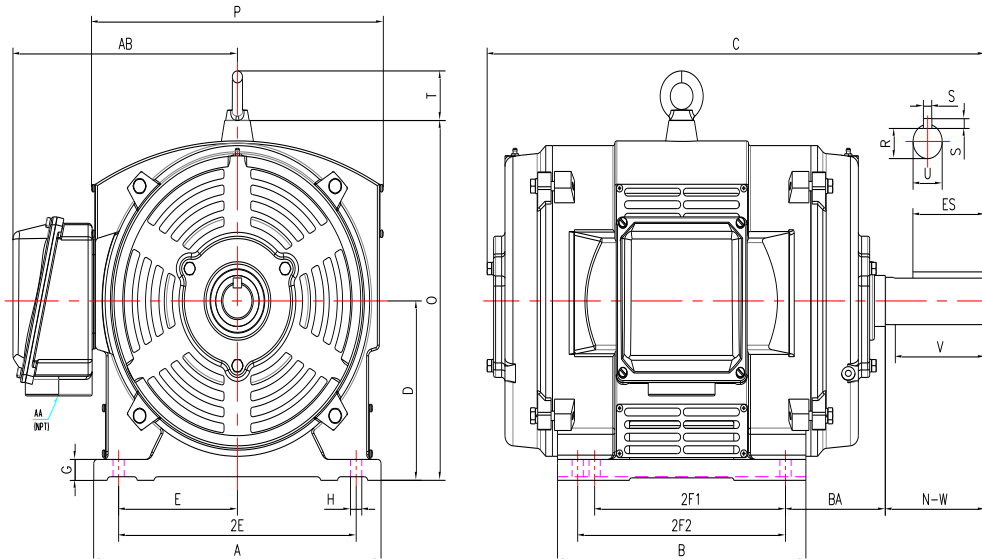

DIMENSIONS

HP	RPM	Frame	MOUNTING														
			A	B	C	D	G	H	J	E	2E	2F1	2F2	O	P	T	BA
60	3600	326TS	14.60	13.95	25.60	8.00	0.85	0.66	NA	6.25	12.50	10.50	12.00	16.10	15.35	2.60	5.25

Shaft Extension, Key Set						Conduit Box		Bearings		Mount
U	V	R	S	ES	N-W	AA	AB	DE	ODE	
1.88	3.50	1.59	0.50	2.03	3.75	2.00	11.40	6312	6312	F1

BEARING LUBRICATION: The bearings come lubricated with Mobil Polyrex EM Polyurea Grease. It is recommended that you add some additional lubrication when the motor is installed.

Three options (brands) for suitable lubrication include, but are not limited to, the following:

- 1.) Mobil Polyrex EM
- 2.) Citco Polyurea MP
- 3.) Conoco Phillips Polytac EP





PE326TS-60-2-ODP

GENERAL PURPOSE ELECTRIC MOTOR

NEMA PREMIUM EFFICIENCY

CAST IRON CONSTRUCTION - OPEN DRIP PROOF







INVERTER DUTY 10:1 CT; 20:1 VT - NEMA MG1 PART 31

PERFORMANCE DATA

HP	RPM	Frame	Voltage	Frequency (Hz)	Full Load S.F.	Insulation Class	NEMA Design	Slip (%)	NEMA Code	Enclosure Type	IP Rating	Max. Ambient
60	3550	326TS	208-230/460	60	1.15	F	B	1.39	G	ODP	23	40° C

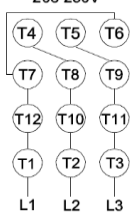
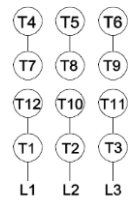
Amps (460V)		Efficiency (%)				Power Factor			Torque (ft-lb)			DE Bearing	ODE Bearing	Connection	Weight (lbs.)
FLA	LRA	100%	75%	50%	Min.	100%	75%	50%	FLT	LRT %	BDT %				
66.0	435.0	93.6	93.0	92.4	92.4	0.91	0.89	0.84	88.6	170	255	6312	6312	12 Lead 2Δ/Δ	554

NAME PLATE

 North American Electric, Inc.													CONNECTION DIAGRAMS 208-230V 		
INVERTER DUTY 20:1 VT; 10:1 CT															
CAT NO: PE326TS-60-2-ODP			FRAME 326TS			PHASE 3						460V 			
HZ 60	S.F. 1.15	HZ 50	S.F. 1.0	ENCL ODP	IP 23										
HP 60	RPM 3550	HP 60	RPM 2960	DUTY CONT	DES B										
VOLTS 208-230/460			VOLTS 190/380			AMB 40° C			INS F						
FLA 146 - 132 / 66	FLA 160/80			DE BEARING 6312											
CODE G	P.F. 0.91	CODE D	P.F. 0.93	ODE BEARING 6312											
EFF 93.6	MIN 92.4	EFF 92	MIN 90.8	LUB: Mobil Polyrex EM											
MOTOR WEIGHT 554 LBS		CONNECTION 12 Lead 2Δ/Δ			SER NO										
General purpose use on industrial machinery installed in environments with minimal dirt and moisture. Hernando, Mississippi										   CC 082A					

APPLICATIONS:

General purpose use on pumps, fans, blowers, compressors, conveyors, material handling and other industrial machinery installed in environments with minimal dirt and moisture.