

PE284TS-30-2-ODP

GENERAL PURPOSE ELECTRIC MOTOR
NEMA PREMIUM EFFICIENCY
CAST IRON CONSTRUCTION - OPEN DRIP PROOF
INVERTER DUTY 10:1 CT; 20:1 VT - NEMA MG1 PART 31

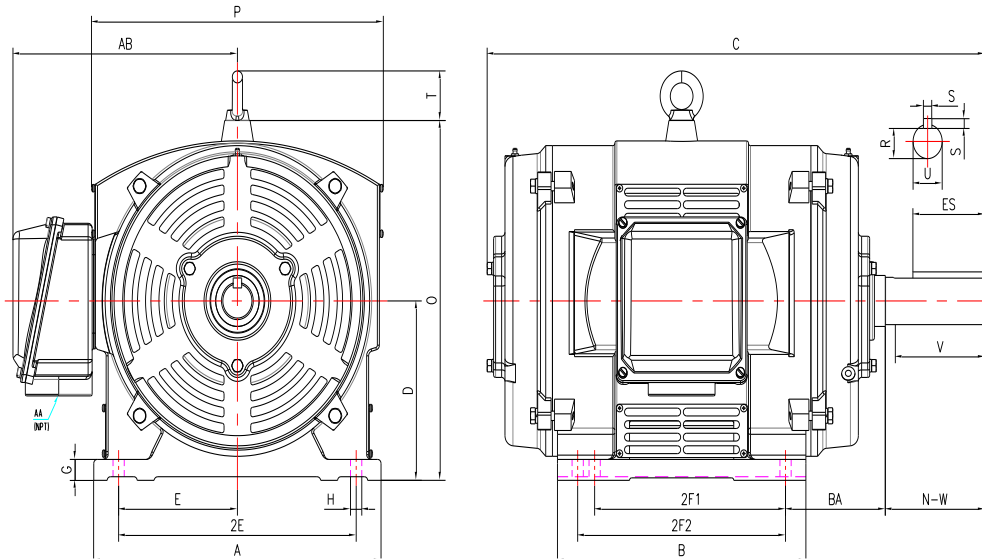

DIMENSIONS

HP	RPM	Frame	MOUNTING														
			A	B	C	D	G	H	J	E	2E	2F1	2F2	O	P	T	BA
30	3600	284TS	13.00	12.80	23.43	7.00	0.70	0.53	NA	5.50	11.00	9.50	11.00	14.30	13.95	2.20	4.75

Shaft Extension, Key Set						Conduit Box		Bearings		Mount
U	V	R	S	ES	N-W	AA	AB	DE	ODE	
1.63	3.00	1.42	0.38	1.91	3.25	1.50	10.10	6311	6311	F1

BEARING LUBRICATION: The bearings come lubricated with Mobil Polyrex EM Polyurea Grease. It is recommended that you add some additional lubrication when the motor is installed.

Three options (brands) for suitable lubrication include, but are not limited to, the following:

- 1.) Mobil Polyrex EM
- 2.) Citco Polyurea MP
- 3.) Conoco Phillips Polytac EP





PE284TS-30-2-ODP

GENERAL PURPOSE ELECTRIC MOTOR

NEMA PREMIUM EFFICIENCY

CAST IRON CONSTRUCTION - OPEN DRIP PROOF







INVERTER DUTY 10:1 CT; 20:1 VT - NEMA MG1 PART 31

PERFORMANCE DATA

HP	RPM	Frame	Voltage	Frequency (Hz)	Full Load S.F.	Insulation Class	NEMA Design	Slip (%)	NEMA Code	Enclosure Type	IP Rating	Max. Ambient
30	3545	284TS	208-230/460	60	1.15	F	B	1.53	G	ODP	23	40° C

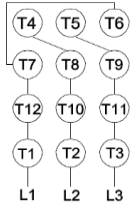
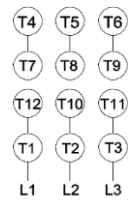
Amps (460V)		Efficiency (%)				Power Factor			Torque (ft-lb)			DE Bearing	ODE Bearing	Connection	Weight (lbs.)
FLA	LRA	100%	75%	50%	Min.	100%	75%	50%	FLT	LRT %	BDT %	6311	6311	12 Lead 2Δ/Δ	374
35.0	217.0	91.7	91.5	90.5	90.2	0.88	0.85	0.78	44.6	150	260				

NAME PLATE

 North American Electric, Inc.															CONNECTION DIAGRAMS 208-230V 		
INVERTER DUTY 20:1 VT; 10:1 CT																	
CAT NO: PE284TS-30-2-ODP			FRAME 284TS				PHASE 3										
HZ 60	S.F. 1.15	HZ 50	S.F. 1.0	ENCL ODP	IP 23												
HP 30	RPM 3545	HP 30	RPM 2915	DUTY CONT	DES B												
VOLTS 208-230/460		VOLTS 190/380		AMB 40° C	INS F												
FLA 77 - 70 / 35	FLA 82/41		DE BEARING 6311														
CODE G	P.F. 0.88	CODE E	P.F. 0.91	ODE BEARING 6311													
EFF 91.7	MIN 90.2	EFF 90	MIN 88.5	LUB: Mobil Polyrex EM													
MOTOR WEIGHT 374 LBS	CONNECTION 12 Lead 2Δ/Δ		SER NO						460V 								
General purpose use on industrial machinery installed in environments with minimal dirt and moisture. Hernando, Mississippi										  		CC 082A					

APPLICATIONS:

General purpose use on pumps, fans, blowers, compressors, conveyors, material handling and other industrial machinery installed in environments with minimal dirt and moisture.